

# **G32410GSM**

**24-Gigabit SFP Port + 8-Gigabit Combo Port +  
4-10Gigabit SFP Port**

## **Web Manual**

**Ver. 1.0**

Revision history

<b>Date</b>	<b>Version</b>	<b>Description</b>
May. 16, 2022	V 1.0	The first edition

# Contents

G32410GSM.....	1
24-Gigabit SFP Port + 8-Gigabit Combo Port + 4-10Gigabit SFP Port.....	1
Web Manual.....	1
Ver. 1.0.....	1
Contents.....	3
1 Foreword.....	9
1.1 Target Audience.....	9
1.2 Manual Convention.....	9
2 Web Page Login.....	9
2.1 Log in the Network Management Client.....	9
2.2 Constitution of Client Interface.....	10
2.3 Navigation Bar on Web Interface.....	10
3 Status.....	18
3.1 System Information.....	18
3.2 Statistics.....	18
3.3 MAC Address Table.....	19
3.4 Reboot.....	20
3.5 Management IP Address.....	21
4 Network.....	21
4.1 DNS.....	21
4.2 System Time.....	23
5 Port.....	24
5.1 Port Setting.....	24
5.2 Error Disabled.....	26
5.3 Link Aggregation.....	26
5.3.1 Group.....	27
5.3.2 Port Setting.....	30
5.3.3 LACP.....	30
5.4 EEE.....	33

5.5 Jumbo Frame .....	34
5.6 Port Security .....	34
5.7 Protected Port.....	35
5.8 Storm Control .....	36
5.9 Mirroring .....	38
6 VLAN.....	40
6.1 VLAN.....	41
6.1.1 Create VALN.....	41
6.1.2 VLAN Configuration .....	42
6.1.3 Membership .....	43
6.1.4 Port Setting .....	44
6.2 Voice VLAN.....	47
6.3 Protocol VLAN.....	52
6.4 MAC VLAN .....	57
6.5 Surveillance VLAN.....	60
6.6 GVRP .....	62
6.6.1 Property .....	63
6.6.2 Membership .....	65
6.6.3 Statistics .....	65
7 MAC Address Table.....	66
7.1 Dynamic Address .....	66
7.2 Static Address .....	67
7.3 Filtering Address .....	68
7.4 Port Security Address .....	69
8 Spanning Tree .....	70
8.1 Property .....	71
8.2 Port Setting .....	72
8.3 MST Instance .....	74
8.4 MST Port Setting .....	75
8.5 Statistics .....	80

9 Discovery .....	80
9.1 LLDP .....	81
9.2 Port Setting .....	82
9.3 MED Network Policy.....	84
9.4 MED Port Setting .....	85
9.5 Packet View.....	87
9.6 Local Information .....	87
9.7 Neighbor .....	88
9.8 Statistics .....	88
10 DHCP.....	89
10.1 Property .....	92
10.2 IP Pool Setting .....	93
10.3 VLAN IF Address Group Setting .....	94
10.4 Client List.....	95
10.5 Client Static Binding Table .....	96
11 Multicast.....	96
11.1 General .....	96
11.1.1 Property .....	96
11.1.2 Group Address .....	97
11.1.3 Router Port.....	99
11.1.4 Forward All .....	99
11.1.5 Throttling .....	99
11.1.6 Filtering Profile .....	100
11.2 IGMP Snooping .....	101
11.2.1 Property .....	102
11.2.2 Querier.....	104
11.2.3 Statistics .....	104
11.3 MLD Snooping .....	105
11.3.1 Property .....	106
11.3.2 Statistics .....	108

11.4 MVR .....	108
11.4.1 Property .....	109
11.4.2 Port Setting .....	111
11.4.3 Group Address .....	112
12 Routing .....	112
12.1 IPv4 Management and Interfaces .....	113
12.1.1 IPv4 Interface .....	113
12.1.2 IPv4 Routes .....	114
12.1.3 ARP .....	114
12.2 IPv6 Management and Interfaces .....	116
12.2.1 IPv6 Interface .....	116
12.2.2 IPv6 Address .....	117
12.2.3 IPv6 Routes .....	117
12.2.4 Neighbors .....	118
12.3 Rip Routes Management .....	119
12.4 Ospf Routes Management .....	121
13 Security .....	123
13.1 RADIUS .....	123
13.2 TACACS+ .....	125
13.3 AAA .....	126
13.3.1 Method List .....	126
13.3.2 Login Authentication .....	128
13.4 Management Access .....	128
13.4.1 Management Service .....	128
13.4.2 Management ACL .....	130
13.5 Authentication Manager .....	132
13.5.1 Property .....	132
13.5.2 Port Setting .....	134
13.5.3 MAC-Based Local Account .....	136
13.5.4 WEB-Based Local Account .....	136

13.5.5 Sessions .....	137
13.6 DoS.....	137
13.6.1 Property .....	137
13.6.2 Port Setting .....	138
13.7 Dynamic ARP Inspection .....	139
13.7.1 Property .....	139
13.7.2 Statistics .....	140
13.8 DHCP Snooping .....	140
13.8.1 Property .....	141
13.8.2 Statistics .....	143
13.8.3 Option82 Property .....	143
13.9 IP Source Guard .....	149
13.9.1 Port Setting .....	149
13.9.2 IMPV Binding .....	150
14 ACL.....	152
14.1 MAC ACL .....	153
14.2 IPv4 ACL .....	155
14.3 IPv6 ACL .....	157
14.4 ACL Binding .....	160
15 QoS.....	161
15.1 General .....	163
15.1.1 Property .....	163
15.1.2 Queue Scheduling .....	164
15.1.3 CoS Mapping .....	165
15.1.4 DSCP Mapping .....	166
15.1.5 IP Precedence Mapping .....	168
15.2 Rate limit .....	169
15.2.1 Ingress / Egress Port .....	169
15.2.2 Egress Queue.....	170
16 Diagnostics.....	171

16.1 Logging .....	171
16.2 Ping .....	173
16.3 Traceroute .....	174
16.4 Copper Test.....	175
16.5 Fiber Module.....	175
16.6 UDLD.....	176
16.6.1 Property .....	176
16.6.2 Neighbor.....	177
17 Management .....	178
17.1 User Account.....	178
17.2 Firmware .....	179
17.3 Configuration .....	180
17.3.1 Manual Upgrade .....	180
17.3.2 Save Configuration .....	180
17.4 SNMP .....	181
17.4.1 View .....	183
17.4.2 Group .....	183
17.4.3 Community .....	185
17.4.4 User .....	185
17.4.5 Engine ID.....	187
17.4.6 Trap Event.....	187
17.4.7 Notification .....	188
17.5 RMON.....	189
17.5.1 Statistics .....	190
17.5.2 History .....	191
17.5.3 Event.....	192
17.5.4 Alarm .....	193

# 1 Foreword

## 1.1 Target Audience

This manual is prepared for the installers and system administrators who are responsible for network installation, configuration and maintenance. It assumes that the user has understood all network communication and management protocols, as well as the technical terms, theoretical principles, practical skills, and expertise of devices, protocols and interfaces related to networking. Work experience in Graphical User Interface (GUI), Command-line Interface, Simple Network Management Protocol (SNMP) and Web Explorer is also required.

## 1.2 Manual Convention

The following approaches should prevail.

GUI Convention	Description
Interpretation	Describe operations and add necessary information.
 Caution	Remind the user of cautions as improper operations will result in data loss or equipment damage.

# 2 Web Page Login

## 2.1 Log in the Network Management Client

Type in the default switch address: **http://192.168.2.1** and press “Enter”.



Description:

Browser standards: superior to IE 9.0, Chrome 23.0 and Firefox 20.0

Keep the IP network segment of PC consistent with that of switch but differentiate the IP address as you log in. Set PC's IP address of **192.168.2.x** and the subnet mask of **255.255.255.0** for the first login ( $1 < x \leq 254$ ).

A login window appears as follows. Type in the default username of “**admin**” and

the password of “admin”. Click the “Log in” to see the switch system.

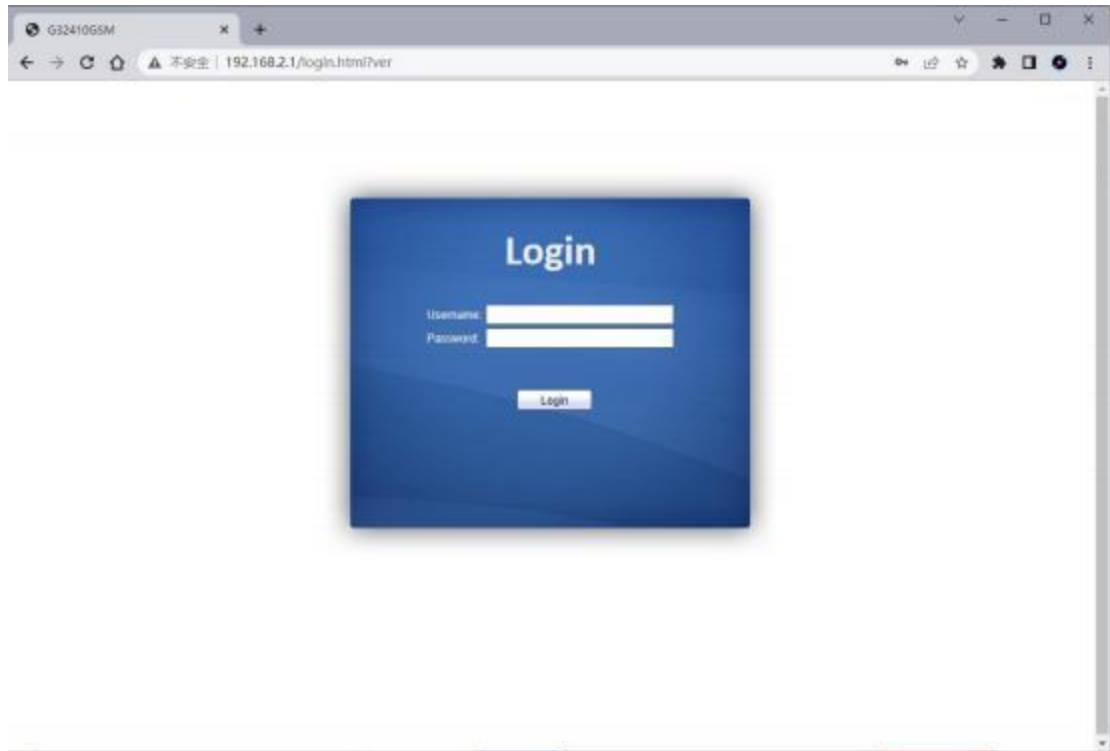

## 2.2 Constitution of Client Interface

The typical operation interface of Web network management system is as follows.

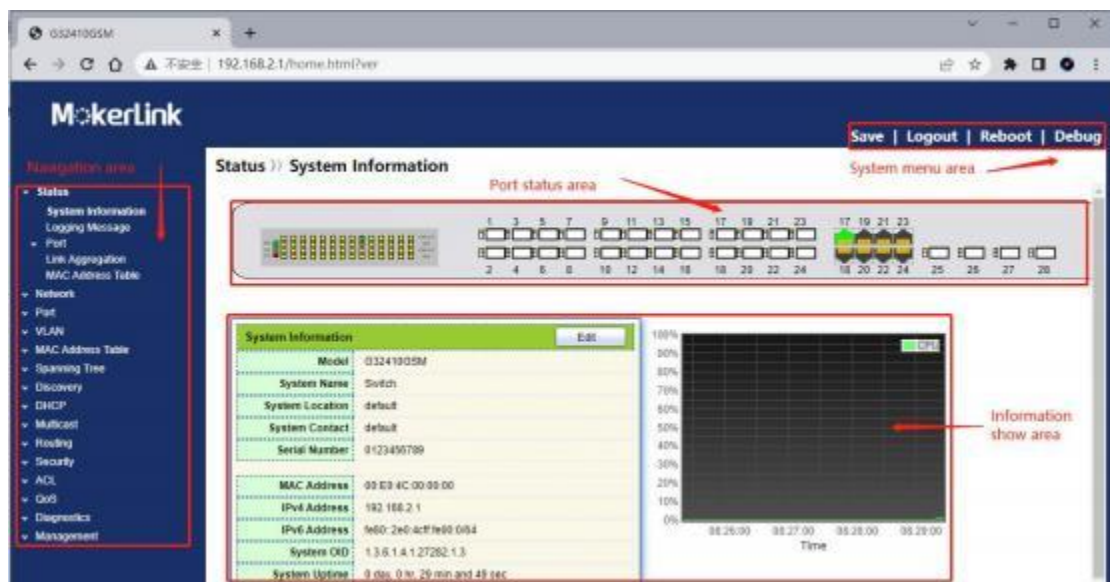

## 2.3 Navigation Bar on Web Interface

Menu items such as State, Network, Port, VLAN, MAC Address Table, Spanning Tree,

Discovery, DHCP, Multicast, Routing, Security, ACL, QoS, Diagnostics and Management are available on the web network management client. Each item contains submenus. Navigation bar is detailed as follows:

Menu Items	Submenus	Secondary Submenus	Description	
Status	System Information		Display the port state and product info	
	Logging Message		Display the device running and operation logs	
	Port	Statistics		Display the detailed port statistics
		Error Disabled		Display the faults occurring to ports
		Bandwidth Utilization		Display the bandwidth utilization per unit time of all ports
	Link Aggregation		Display the aggregation group state and members	
	MAC Address Table		Display the MAC address table of the current device	
Network	DNS		Configure and view the DNS and server setting	
	Hosts		Configure and view the DNS Server and dynamic host mapping table	
	System Time		Configure and view the current system time	
Port	Port Setting		Configure and view all ports	
	Error Disabled		Configure and view the port error disable protection	
	Link Aggregation	Group		Configure and view the port & strategy balancing algorithms contained in LAG
		Port Setting		Configure and view the LAG
		LACP		Check LACP system priority and port configuration
	EEE		Configure and view the EEE state and information	
	Jumbo Frame		Configure and view the length of the max message forwarded by system	
	Port Security		Configure and view the rate limiting of port security, as well as port state	
	Protected Port		Configure and view the port isolation	

	Storm Control		Configure and view the port storm policing
	Mirroring		Configure and view the port mirroring
VLAN	VLAN	Create VLAN	Configure and view the VLAN info of the device
		VLAN Configuration	Configure and view the VLAN configuration of all ports
		Membership	Configure and view the port info of VLANs
		Port Setting	Configure and view the PVID and VLAN attributes of ports
	Voice VLAN	Property	Configure and view Voice-VLAN function and port status information
		Voice OUI	Configure and view Voice-VLAN OUI information
	Protocol VLAN	Protocol Group	Configure and view the protocol VLAN group
		Group Binding	Configure and view the protocol VLAN port and group binding.
	MAC VLA	MAC Group	Configure and view the MAC VLAN group
		Group Binding	Configure and view the MAC VLAN port and group binding
	Surveillance VLAN	Property	Configure and view Surveillance-VLAN function and port status information
		Surveillance OUI	Configure and view Surveillance-VLAN OUI information
	GVRP	Property	Configure and view the functional global and port state
		Membership	Configure and view the VLANs learned and the port members
		Statistics	Configure and view the message statistics related to ports
MAC Address Table	Dynamic Address		Configure and view the dynamic MAC addresses and aging time of the device
	Static Address		Configure and view the static MAC address tables of the device
	Filtering Address		Configure and view the MAC

			address tables to be filtered
	Port Security Address		Configure and view the MAC address table learned by port security
Spanning Tree	Property		Configure and view the STP state and attributes
	Port Setting		Configure and view the port attributions of STP
	MST Instance		Configure and view the instance attributes of STPs
	MST Port Setting		Configure and view the instances (incl. port info) of STPs
	Statistics		Configure and view the STP message statistics of each port
Discovery	LLDP	Property	Configure and view the attributes related to LLDP
		Port Setting	Configure and view the transmitting & receiving state of LLDP at each port
		MED Network Policy	Configure and view the MED network strategy table entry
		MED Port Setting	Configure and view the MED state at each port
		Packet View	Configure and view the detailed LLDP messages at each port
		Local Information	Configure and view the LLDP and LLDP-MED state
		Neighbor	Configure and view the LLDP neighbor info
		Statistics	Configure and view the transmitting & receiving state of LLDP message at each port
DHCP	Property		Configure and view DHCP service switches and port switches
	IP Pool Setting		Configure and view DHCP server IP address pool
	VLAN IF Address Group Setting		Configure and view VLANIF and DHCP server group binding relationship
	Client List		View the list of DHCP clients
	Client Static		Configure and view DHCP client

	Binding Table		static binding table entries
Multicast	General	Property	Configure and view the function configuration
		Group Address	Configure and view the relevant static multicast info
		Router Port	Configure and view the multicast routed port info
		Forwarding All	Configure and view the multicast forwarding port info
		Throttling	Configure and view the multicast limit at each port
		Filtering Profile	Configure and view the multicast addresses filtered
		Filtering Binding	Configure and view the binding info related to filtering rule and ports
	IGMP Snooping	Property	Configure and view the switch, version, etc.
		Querier	Configure and view the querier state
		Statistics	Configure and view the protocol messages
	MLD Snooping	Property	Configure and view the protocol, switch, etc.
		Statistics	Configure and view the protocol messages
	MVR	Property	Configure and view the attribute info such as switch
		Port Setting	Configure and view the state at each port
		Group Address	Configure and view the function, VLAN and group address
Routing	IPv4 Management and Interfaces	IPv4 Interface	Configure and view VLANIF IPv4 address information
		IPv4 Routes	Configure and view IPv4 static routes
		ARP	Configure and view ARP table
	IPv6 Management and Interfaces	IPv6 Interface	Configure and view VLANIF IPv6 interface information
		IPv6 Address	Configure and view VLANIF IPv6 address information
		IPv6 Routes	Configure and view IPv6 static routes

		IPv6 Neighbors	Configure and view IPv6 neighbors table
	Rip Routes Management	Rip Routes Setting	Configure and view RIP routes
	Ospf Routes Management	Ospf Routes Setting	Configure and view OSPF routes
Security	RADIUS		Configure to view RADIUS server related information
	TACACS+		Configure to view TACACS+ server related information
	AAA	Method List	Configure and view the login authentication method
		Login Authentication	Configure and view the authentication methods of terminals
	Management Access	Management Service	Configure and view the service management mode and relevant attributes
		Management ACL	Configure and view the ACL aiming at management channels
		Management ACE	Configure and view the ACE configuration of management channels
	Authentication Management	Property	Configure and view the authentication attributes
		Port Setting	Configure and view the authentication info at each port
		MAC Local Account	Configure and view the list of MAC local accounts
		Web Local Account	Configure and view the list of Web local accounts
		Sessions	Configure and view the info related to session authentication
	DoS	Property	Configure and view the switch option
		Port Setting	Configure and view the switch option at ports
	Dynamic ARP Inspection	Property	Configure and view the dynamic ARP inspection
		Statistics	Configure and view the messages statistics in APR inspection state at each port

	DHCP Snooping	Property	Configure and view the switch and state
		Statistics	Configure and view the DHCP message statistics received by each port
		Option82 Property	Configure and view the attributes related to Option 82
		Option82 Circuit ID	Configure and view the Circuit ID of Option 82
	IP Source Guard	Port Setting	Configure and view the state at ports
		IMPV Binding	Configure and view the binding tables of IP, MAC, Port and VLAN
Save Database		Configure and view the storage and info of the binding table entry	
ACL	MAC ACL		Configure and view the MAC ACL rules
	MAC ACE		Configure and view the MAC ACE table entries
	IPv4 ACL		Configure and view the IPv4 ACL rules
	IPv4 ACE		Configure and view the IPv4 ACE table entries
	IPv6 ACL		Configure and view the IPv6 ACL rules
	IPv6 ACE		Configure and view the IPv6 ACE table entries
	ACL Binding		Configure and view the ACL rules and the port binding application
QoS	General	Property	Configure and view the QoS switch and state
		Queue Scheduling	Configure and view the algorithm of queue scheduling
		CoS Mapping	Configure and view the priority and local queue mapping table
		DSCP Mapping	Configure and view the priority and local queue mapping table
		IP Precedence Mapping	Configure and view the priority and local queue mapping table
	Rate Limit	Ingress/Egress Port	Configure and view the configuration of port rate limiting

		Egress Queue	Configure and view the rate limiting configuration based on egress queue
Diagnostics	Logging	Property	Configure and view the switch and state
		Remote Server	Configure and view the address of remote servers
	Ping		Network diagnostics by Ping
	Traceroute		Network diagnostics by traceroute
	Copper Test		Electrical interface link diagnostics by VCT
	Fiber Module		Check the SFP module at optical interfaces
	UDLD	Property	Configure and view the switch and state
		Neighbor	Configure and view the neighbor state
Management	User Account		Configure and view the user info
	Firmware	Manual Upgrade	Update software
	Configuration	Manual Upgrade	Update configuration files
		Save Configuration	Save the configuration files supporting device running
	SNMP	View	Configure and view the SNMP function view table entry
		Group	Configure and view the SNMP group
		Community	Configure and view the SNMP Community
		User	Configure and view the SNMP user attributes
		Engine ID	Configure and view the SNMP and remote Engine IDs
		Trap Event	Configure and view the SNMP Trap switch and state
		Notification	Configure and view the SNMP Notification server state
	RMON	Statistics	Configure and view the message statistics history of all ports
		History	Configure and view the history record state
		Event	Configure and view the event state

		Alarm	Configure and view the alarm state
--	--	-------	------------------------------------

### 3 Status

#### 3.1 System Information

According to the switch connected, web network management panel directly displays the port and product info, incl.: number of ports, port states, product info, device states, function on-off states, etc.

Instructions:

1. Click the “Status > System Information” in the navigation bar as follows:

Status >> System Information

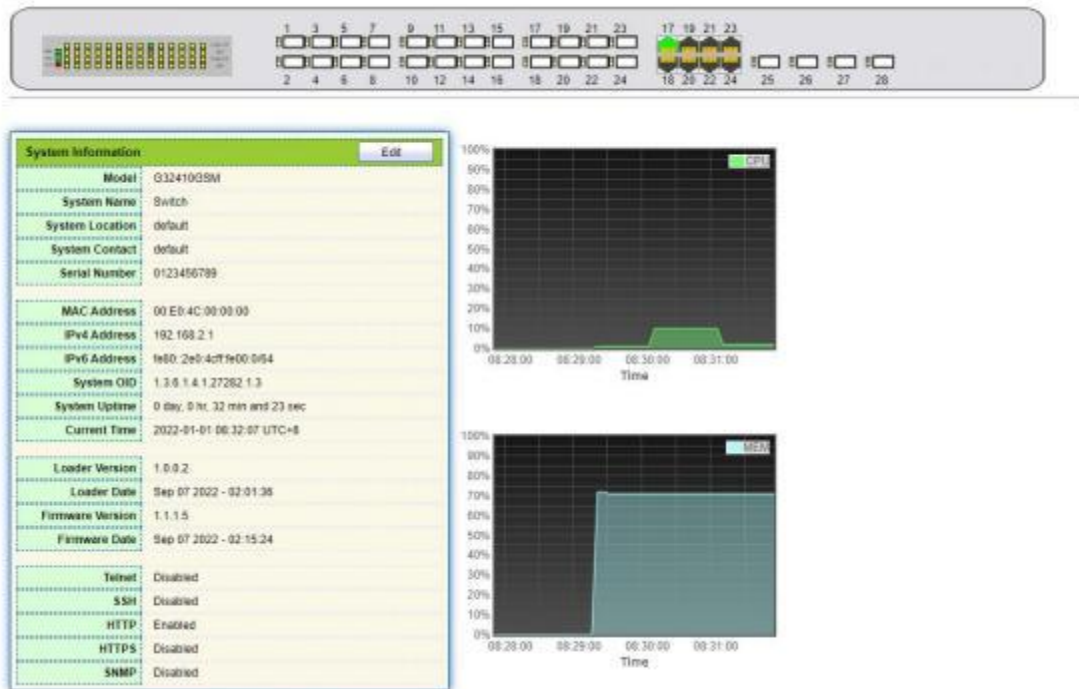

Description:

Mouseover a port to check the port No., type, rate and state. “Edit” the “System Name”, “Location” and “Contact” in the product info. “Apply” and finish.

#### 3.2 Statistics

Introduce the detailed flow statistics at a port and the info to be refreshed or cleared

manually by users.

1. Click the “Status > Port > Statistics” in the navigation bar as follows:

The screenshot shows a configuration panel for port statistics. It includes a dropdown menu for the port (GE3), radio buttons for MIB Counter (All, Interface, Etherlike, RMON) and Refresh Rate (None, 5 sec, 10 sec, 30 sec), and a Clear button. Below the configuration is a table of interface statistics.

Interface	
ifInOctets	60938
ifInUcastPkts	210
ifInNUcastPkts	318
ifInDiscards	0
ifOutOctets	185965
ifOutUcastPkts	212
ifOutNUcastPkts	1422
ifOutDiscards	0
ifInMulticastPkts	160
ifInBroadcastPkts	158
ifOutMulticastPkts	770
ifOutBroadcastPkts	652

 Description:

“Clear” the flow statistics at the current port and refresh the page.

### 3.3 MAC Address Table

View MAC address table information

Instructions:

1. Click the “Status > MAC Address Table” in the navigation bar as follows:

## MAC Address Table

Showing  entries      Showing 1 to 2 of 2 entries     

VLAN	MAC Address	Type	Port
1	1C:2A:A3:00:34:24	Management	CPU
1	00:E0:4C:2E:2C:DD	Dynamic	GE1

                

Interface data are as follows.

Query Items	Description
MAC	Destination MAC Address
VLAN	VLAN ID belonging to MAC address
Port	Message egress corresponding to MAC address
Type	Dynamic MAC Address refers to the entry which will age with the set aging time. Switches can add entries based on the learning mechanism of MAC address or manual creation. Static MAC address refers to the specified table which is manually configured and won't age. Management MAC address refers to the address at the management port.

## 3.4 Reboot

1. Click the "Reboot" on the upper right as guided as follows.

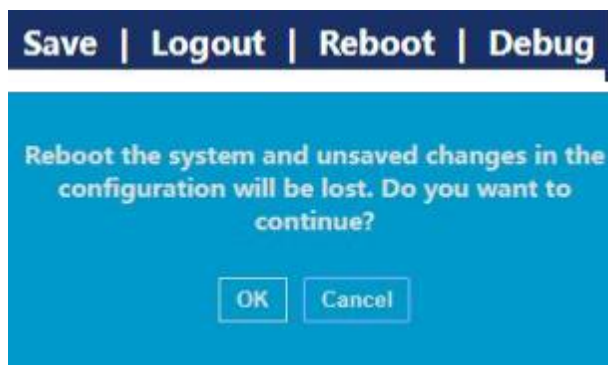

## 3.5 Management IP Address

Change the management IP address on web interface.

Instructions:

1. Click the “Routing > IPv4 Management and Interfaces > IPv4 Interface” in the navigation bar to discover IPv4 address of **192.168.2.1/24** by default as follows:

**IPv4 Interface Table**

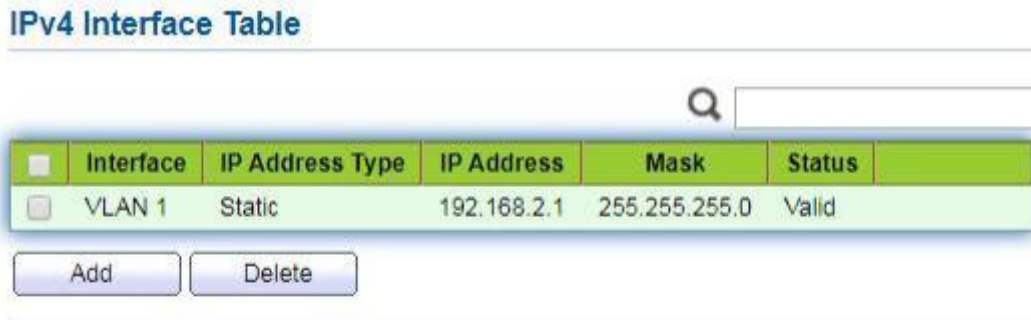

<input type="checkbox"/>	Interface	IP Address Type	IP Address	Mask	Status
<input type="checkbox"/>	VLAN 1	Static	192.168.2.1	255.255.255.0	Valid

## 4 Network

### 4.1 DNS

DNS is short for Domain Name System to name computers and network services from units to domain hierarchies. A domain name consists of the dots separated by a series of words or abbreviations, each corresponding to a unique IP address. DNS is the server on the Internet that resolves domain names. Applicable to Internet and other TCP/IP networks, DNS name retrieves computers and services through user-friendly names. As one of the core Internet services, DNS is a distributed database that maps domain names and IP addresses mutually.

Instructions:

1. Click on the “Network > DNS” in the navigation bar as follows.

## DNS Configuration

<b>DNS Status</b>	<input type="radio"/> Disable
	<input checked="" type="radio"/> Enable
<b>DNS Default Name</b>	<input type="text"/> (1 to 255 alphanumeric characters)

Apply

## DNS Server Configuration

Q

<input type="checkbox"/>	Preference	DNS Server
0 results found.		

Add Delete

Interface data are as follows.

Configuration Items	Description
DNS State	DNS switch
DNS Default Name	Enter the DNS default name

2. "Add" to configure DNS server.

### Add DNS Server

<b>IPv4/IPv6 Address</b>	<input type="text" value="114.114.114.114"/>
--------------------------	--

Apply Close

3. "Apply" and finish as follows.

## DNS Server Configuration

Q

<input type="checkbox"/>	Preference	DNS Server
<input type="checkbox"/>	1	114.114.114.114

Add Delete

## 4.2 System Time

It is mainly used to configure the system time, and select the time source, daylight-saving time, etc.

Instructions

1. Click on the “Network > System Time” in the navigation bar as follows.

**Source**

SNTP  
 From Computer  
 Manual Time

**Time Zone** UTC +8:00

**SNTP**

**Address Type**  Hostname  
 IPv4

**Server Address**

**Server Port**  (1 - 65535, default 123)

**Manual Time**

**Date**  YYYY-MM-DD

**Time**  HH:MM:SS

**Daylight Saving Time**

**Type**  None  
 Recurring  
 Non-recurring  
 USA  
 European

**Offset**  Min (1 - 1440, default 60)

**Recurring**

From: Day  Week  Month  Time

To: Day  Week  Month  Time

**Non-recurring**

From:  YYYY-MM-DD  HH:MM

To:  YYYY-MM-DD  HH:MM

**Operational Status**

**Current Time** 2022-01-01 10:10:23 UTC+8

Apply

Interface data are as follows.

Configuration Items	Description
Time Source	Select the time source in SNTP, PC or manual modes
Time Zone	Set the time zone
Address Type	Host name or IPv4 address (with time source set by SNTP)

Server Address	Server Address (with time source set by SNTP)
Server Port No.	Server Port No. (with time source set by SNTP)
Date	Date info: DD/MM/YYYY (with time source set in manual mode)
Time	Time info: SS/MM/HH (with time source set in manual mode)
Type	Daylight-saving time types are divided into None, cyclic, non-cyclic, United States and Europe.
Reimbursed Time	Reimbursed Time of daylight-saving time
Cyclic Mode	Configure the cyclic mode of daylight-saving time
Non-cyclic Mode	Configure the non-cyclic mode of daylight-saving time

## 5 Port

### 5.1 Port Setting

Interfaces should be identified so that users can inquire and configure Ethernet interfaces as they want.

Instructions:

1. Click the “Port > Port Setting” in the navigation bar:

**Port Setting Table**

Entry	Port	Type	Description	State	Link Status	Speed	Duplex	Flow Control
1	GE1	1000M Copper		Enabled	Down	Auto	Auto	Disabled
2	GE2	1000M Copper		Enabled	Down	Auto	Auto	Disabled
3	GE3	1000M Copper		Enabled	Down	Auto	Auto	Disabled
4	GE4	1000M Copper		Enabled	Down	Auto	Auto	Disabled
5	GE5	1000M Copper		Enabled	Down	Auto	Auto	Disabled
6	GE6	1000M Copper		Enabled	Down	Auto	Auto	Disabled
7	GE7	1000M Copper		Enabled	Down	Auto	Auto	Disabled

2. Select the port(s) to be configured, and “Edit” as follows:

Edit Port Setting

Port	GE1-GE3
Description	<input type="text"/>
State	<input checked="" type="checkbox"/> Enable
Speed	<input checked="" type="radio"/> Auto
	<input type="radio"/> Auto - 10M
	<input type="radio"/> Auto - 100M
	<input type="radio"/> Auto - 1000M
	<input type="radio"/> Auto - 10M/100M
	<input type="radio"/> 10M
Duplex	<input checked="" type="radio"/> Auto
	<input type="radio"/> Full
	<input type="radio"/> Half
Flow Control	<input type="radio"/> Auto
	<input type="radio"/> Enable
	<input checked="" type="radio"/> Disable

Interface data are as follows

Configuration Items	Description
Port	Port list
Description	Port alias
State	Enable or disable port
Speed	Configurable auto negotiation with mandatory 10 Mb, 100 Mb and 1,000 Mb states. Interface rates including 10 Mbit/s, 100 Mbit/s and 1,000 Mbit/s are available to Ethernet electrical interfaces and are optional as required.
Duplex	Configurable auto negotiation with full or half duplexes.
Flow Control	<p>After it is enabled on both local network and opposite network devices, the local one will notify the other to stop transmitting messages in the presence of network congestion. The opposite one will execute the command temporarily to ensure zero message loss.</p> <p>Disable-Disabled reception and transmission of PAUSE frame;                      Enable-Enabled reception and transmission of PAUSE frame;                      Auto negotiation-Negotiate PAUSE frame with opposite network devices automatically.</p>

## 5.2 Error Disabled

In general, if the software of the switch detects some errors in the port, the port will be closed immediately. In other words, when the operating system of the switch detects some error events on the switch port, the switch will automatically close the port

Instructions:

1. Click the “Port > Error Disabled” in the navigation bar to enable or disable configuration as follows:

Recovery Interval	300	Sec (30 - 86400)
BPDU Guard	<input type="checkbox"/>	Enable
UDLD	<input type="checkbox"/>	Enable
Self Loop	<input type="checkbox"/>	Enable
Broadcast Flood	<input type="checkbox"/>	Enable
Unknown Multicast Flood	<input type="checkbox"/>	Enable
Unicast Flood	<input type="checkbox"/>	Enable
ACL	<input type="checkbox"/>	Enable
Port Security	<input type="checkbox"/>	Enable
DHCP Rate Limit	<input type="checkbox"/>	Enable
ARP Rate Limit	<input type="checkbox"/>	Enable

Apply

## 5.3 Link Aggregation

Link Aggregation broadens bandwidth and reliability by bundling a group of physical interfaces into a single logical interface.

LAG (Link Aggregation Group) is a logical link bundled by multiple Ethernet links (Eth-Trunk).

Ceaselessly expanding network size increases users' demands of link bandwidth and reliability. Traditionally, high-speed interface board or the compatible equipment is usually replaced to optimize bandwidth, which is expensive and inflexible.

Link Aggregation Technology bundles multiple physical interfaces into a single logical interface without upgrading hardware. Its backup mechanism not only improves reliability, but also shares the flow load on different physical links.

As shown below, Switch A is linked with Switch B through three Ethernet links which are bundled into an Eth-Trunk logical link. Its bandwidth equals to that of the three links in total, thus broadening the bandwidth. Meanwhile, these three links back up mutually to be more reliable.

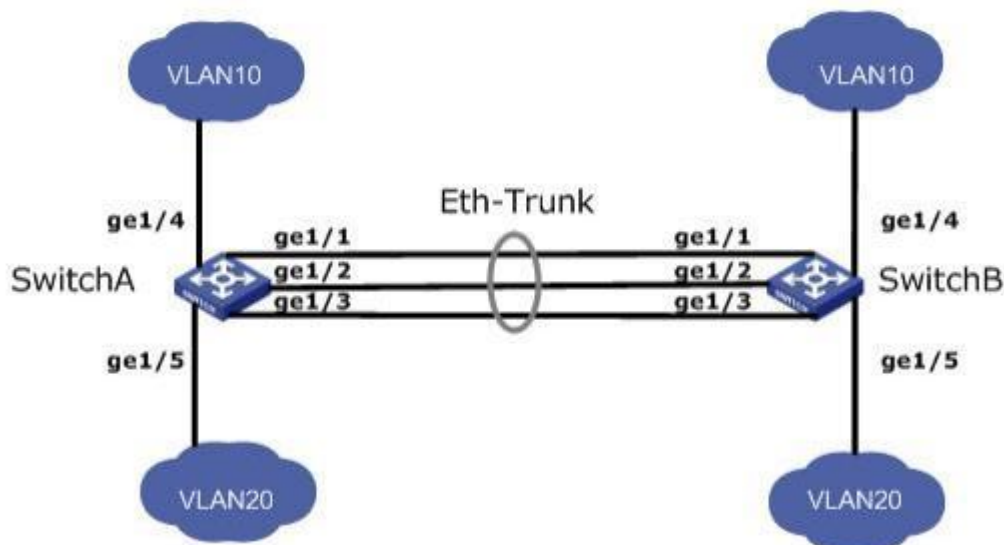

Link Aggregation can meet the following demands:

- Insufficient bandwidth of two switches connected with one link.
- Insufficient reliability of two switches connected with one link.

Link Aggregation can be divided into Manual Mode and LACP Mode in accordance with Link Aggregation Control Protocol (LACP) state.

In the first mode, Eth-Trunk establishment, member interface access should be added manually without LACP. It is also called the Load-sharing Mode because all links are involved in data forwarding and load sharing. In case any active link fails, LAG will average load with the remaining ones. This mode is preferred under the circumstance that two directly connected devices require a larger link bandwidth but has no access to LACP.

### 5.3.1 Group

Instructions for adding a Static Link Aggregation:

1. Click the "Port > Link Aggregation > Group", select a load-balancing algorithm with a radio button. "Apply" and finish as follows:

**Load Balance Algorithm**

MAC Address  
 IP-MAC Address

Apply

### Link Aggregation Table

Q

LAG	Name	Type	Link Status	Active Member	Inactive Member
<input type="radio"/> LAG 1		--	--		
<input type="radio"/> LAG 2		--	--		
<input type="radio"/> LAG 3		--	--		
<input type="radio"/> LAG 4		--	--		
<input type="radio"/> LAG 5		--	--		
<input type="radio"/> LAG 6		--	--		
<input type="radio"/> LAG 7		--	--		
<input type="radio"/> LAG 8		--	--		

Edit

2. Select one of 8 LAGs available, "Edit" the configuration page as follows:

### Edit Link Aggregation Group

**LAG** 1

**Name**

**Type**

Static  
 LACP

**Member**

Available Port

- GE1
- GE2
- GE3
- GE4
- GE5
- GE6
- GE7
- GE8

Selected Port

Apply

Close

Interface data are as follows

Configuration Items	Description
LAG	There are 8 LAGs numbering from 1 to 8.
Name	Description of LAG, which can be modified as needed.
Type	Select from the manual mode and the LACP mode.

Member	Up to 8 member ports are available in LAG.
--------	--

Illustration:

As shown below, Switch A and Switch B connect VLAN 10 and 20 via Ethernet respectively, with large data flow between them.

Both Switch A and B are expected to provide superior link bandwidth for VLAN communication. Meanwhile, there should be the redundancy for reliable data transmission and links.

Networking diagram LAG in manual mode

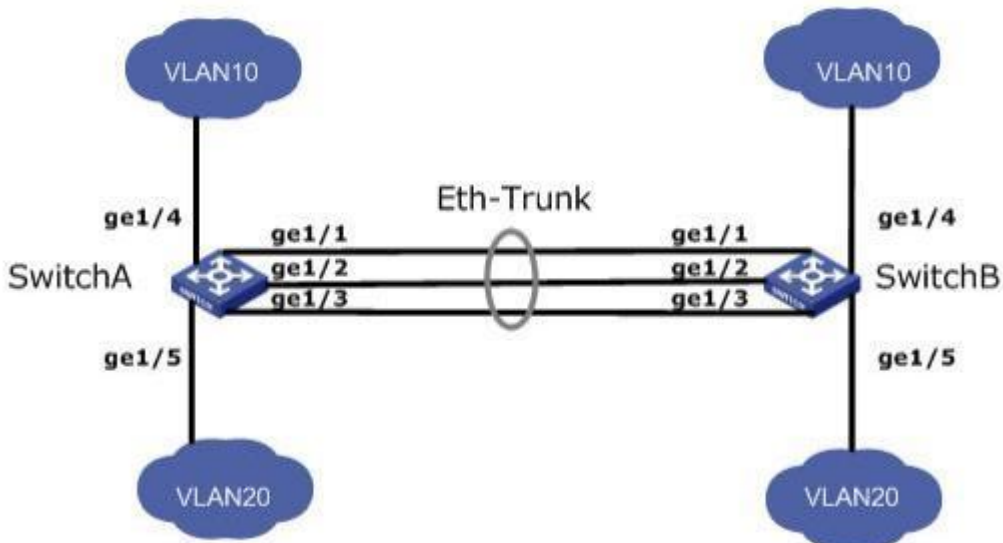

Instructions:

1. Create the ETH trunk interface in SwitchA and add a member interface to increase the link bandwidth. The configuration of SwitchB is like that of SwitchA. Click the “Port > Link Aggregation > Group”, choose “LAG 1” and port GE1, 2 and 3 and move them to the selected ports on the right. “Apply” and finish as follows.

### Link Aggregation Table

LAG	Name	Type	Link Status	Active Member	Inactive Member
<input type="radio"/>	LAG 1	Static	Up	GE3	GE1-GE2
<input type="radio"/>	LAG 2	---	---		
<input type="radio"/>	LAG 3	---	---		
<input type="radio"/>	LAG 4	---	---		

### 5.3.2 Port Setting

Attribute configuration of aggregation group member port

1. Click the “Port > Link Aggregation > Port Setting”, to enter the attribute configuration interface of aggregation group member port as follows:

**Port Setting Table**

<input type="checkbox"/>	LAG	Type	Description	State	Link Status	Speed	Duplex	Flow Control
<input type="checkbox"/>	LAG 1			Enabled	Down	Auto	Auto	Disabled
<input type="checkbox"/>	LAG 2			Enabled	Down	Auto	Auto	Disabled
<input type="checkbox"/>	LAG 3			Enabled	Down	Auto	Auto	Disabled
<input type="checkbox"/>	LAG 4			Enabled	Down	Auto	Auto	Disabled
<input type="checkbox"/>	LAG 5			Enabled	Down	Auto	Auto	Disabled
<input type="checkbox"/>	LAG 6			Enabled	Down	Auto	Auto	Disabled
<input type="checkbox"/>	LAG 7			Enabled	Down	Auto	Auto	Disabled
<input type="checkbox"/>	LAG 8			Enabled	Down	Auto	Auto	Disabled

### 5.3.3 LACP

LACP (Link Aggregation Control Protocol), based on IEEE 802.3ad Standard, dynamically aggregates and disaggregates links. It exchanges info with the opposite network devices through LACPDU (Link Aggregation Control Protocol Data Unit).

After a port uses LACP, it will inform the opposite network device of system priority, system MAC, port priority and No., and operation Key by transmitting a LACPDU. The opposite device will compare such info with that saved by other ports after receiving it, thus reaching an agreement on port participation in or quitting from a dynamic aggregation.

Dynamic LACP aggregation is automatically created or deleted by system, that is, internal ports can be added or removed by themselves. Only the ports connected to a same device with the same rate, duplex, and basic configuration can be aggregated.

Instructions for adding a dynamic link aggregation:

1. Click the “Port > Link Aggregation > Group” in the navigation bar, select the LAG ID and LACP mode, “Edit” them as follows:

### Edit Link Aggregation Group

<b>LAG</b>	2	
<b>Name</b>	<input type="text"/>	
<b>Type</b>	<input type="radio"/> Static <input checked="" type="radio"/> LACP	
<b>Member</b>	Available Port GE1 GE2 GE3 GE7 GE8 GE9 GE10 GE11	Selected Port GE4 GE5 GE6

- Click the “Port >Link Aggregation > LACP” in the navigation bar to configure the LACP attributes such as system priority, port priority and timeout method as follows:

<b>System Priority</b>	<input type="text" value="32768"/>	(1 - 65535, default 32768)
------------------------	------------------------------------	----------------------------

### LACP Port Setting Table

Q

Entry	Port	Port Priority	Timeout
1	GE1	1	Long
2	GE2	1	Long
3	GE3	1	Long
4	GE4	1	Long
5	GE5	1	Long
6	GE6	1	Long
7	GE7	1	Long
8	GE8	1	Long

Interface data are as follows

Configuration Items	Description
System Priority	LACP determines the active and passive modes between two devices subject to priority standard.

Port	Port list
Port Priority	LACP determines the dynamic LAG member mode subject to the port priority with a superior system.
Timeout	It decides the transmission frequency of LACP messages.

 Description:

Please make sure there is no member interface accessing the Eth-Trunk before changing its work pattern, otherwise it fails.

Work pattern of the local network devices should be consistent with that of the opposite network devices.

Illustration

Ethernet Switch A aggregates 3 ports from GE1 to GE3 to Switch B, in order to share the load by each member port.

The following configurations are exemplified by means of dynamic aggregation.

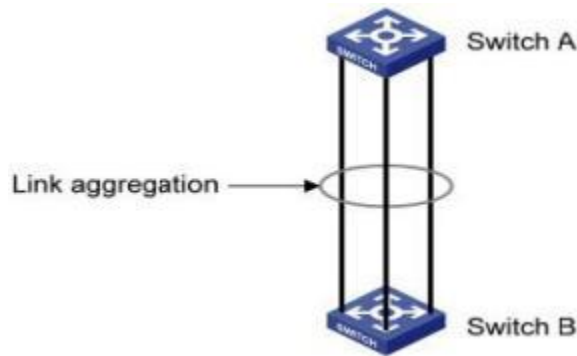

 Description:

The following is the configuration of Switch A only, which should stay the same with that of Switch B for port aggregation.

Instructions:

1. Click the “Port > Link Aggregation > Group” in the navigation bar, “Edit” with LAG 2, select GE1-GE3 in LACP mode. “Apply” and finish as follows:

### Edit Link Aggregation Group

LAG 2

Name

Type  Static  LACP

Member

Available Port Selected Port

GE4 GE1  
GE5 GE2  
GE6 GE3  
GE7  
GE8  
GE9  
GE10  
GE11

Apply Close

## 5.4 EEE

Port power will be turned down in case of zero or less flow

Instructions:

1. Click the “Port > EEE” in the navigation bar, select the port and “Edit” to enter the configuration interface as follows:

### EEE Setting Table

Entry	Port	Type	State
1	GE1	Fiber	Disabled
2	GE2	Fiber	Disabled
3	GE3	Fiber	Disabled
4	GE4	Fiber	Disabled
5	GE5	Fiber	Disabled

### Edit EEE Setting

Port GE17-GE18

State  Enable

Apply Close

2. Set the port enable tag and “Apply” to complete the configuration as follows:

<input type="checkbox"/>	16	GE16	Fiber	Disabled
<input type="checkbox"/>	17	GE17	Copper	Enabled
<input type="checkbox"/>	18	GE18	Copper	Enabled
<input type="checkbox"/>	19	GE19	Copper	Disabled
<input type="checkbox"/>	20	GE20	Copper	Disabled

## 5.5 Jumbo Frame

Set the MTU (Maximum Transmission Unit) of the port

Instructions:

1. Click the “Port > Jumbo Frame” in the navigation bar, enter Jumbo Frame configuration interface as follows:

The screenshot shows the configuration interface for Jumbo Frames. It includes a checkbox labeled 'Enable' which is currently unchecked. Below this is a text input field with the value '10000' and a label 'Byte (1518 - 10000, default 1522)'. An 'Apply' button is located at the bottom of the configuration area.

## 5.6 Port Security

The port security feature records the Ethernet MAC address connected to the switch port through the MAC address table, and only one MAC address can communicate through this port. When packets sent by other MAC addresses pass through this port, port security features prevent it. Using port security features can prevent unauthorized devices from accessing the network and enhance security. In addition, port security features can also be used to prevent MAC address table from filling up due to MAC address flooding

Instructions:

1. Click the “Port > Port Security” in the navigation bar, enter port security configuration interface as follows:

The screenshot shows the configuration interface for Port Security. It includes a checkbox labeled 'Enable' which is currently unchecked. Below this is a text input field with the value '100' and a label 'Packet / Sec (1 - 600, default 100)'. An 'Apply' button is located at the bottom of the configuration area.

2. Click the “Port > Port Security” in the navigation bar, select the port and “Edit” to enter the port level configuration interface as follows:

## Port Security Table

Q

<input type="checkbox"/>	Entry	Port	State	Address Limit	Total	Configured	Violate Number	Violate Action	Sticky
<input type="checkbox"/>	1	GE1	Disabled	1	0	0	0	Protect	Disabled
<input type="checkbox"/>	2	GE2	Disabled	1	0	0	0	Protect	Disabled
<input type="checkbox"/>	3	GE3	Disabled	1	0	0	0	Protect	Disabled
<input type="checkbox"/>	4	GE4	Disabled	1	0	0	0	Protect	Disabled
<input type="checkbox"/>	5	GE5	Disabled	1	0	0	0	Protect	Disabled
<input type="checkbox"/>	6	GE6	Disabled	1	0	0	0	Protect	Disabled
<input type="checkbox"/>	7	GE7	Disabled	1	0	0	0	Protect	Disabled

## Edit Port Security

Port	GE1-GE2
State	<input type="checkbox"/> Enable
Address Limit	<input type="text" value="1"/> (1 - 256, default 1)
Violate Action	<input checked="" type="radio"/> Protect <input type="radio"/> Restrict <input type="radio"/> Shutdown
Sticky	<input type="checkbox"/> Enable

## 5.7 Protected Port

Messages of broadcast, multicast, etc. will flood at each port even though the flow needs no mutual communication sometimes. Under this circumstance, port isolation can separate the messages between two ports.

Instructions:

1. Click the "Port > Protected Port" in the navigation bar, check the port(s) to be isolated, "Edit" to switch this function as follows:

## Protected Port Table

Q

<input type="checkbox"/>	Entry	Port	State
<input type="checkbox"/>	1	GE1	Unprotected
<input type="checkbox"/>	2	GE2	Unprotected
<input type="checkbox"/>	3	GE3	Unprotected
<input type="checkbox"/>	4	GE4	Unprotected
<input type="checkbox"/>	5	GE5	Unprotected
<input type="checkbox"/>	6	GE6	Unprotected
<input type="checkbox"/>	7	GE7	Unprotected

### Edit Protected Port

<b>Port</b>	GE1-GE4
<b>State</b>	<input checked="" type="checkbox"/> Protected

Instructions for achieve port isolation:

1. Click the "Port > Protected Port" in the navigation bar, check and "Edit" the GE1, 2 and 3 to be isolated. "Apply" and finish as follows:

## Protected Port Table

Q

<input type="checkbox"/>	Entry	Port	State
<input type="checkbox"/>	1	GE1	Protected
<input type="checkbox"/>	2	GE2	Protected
<input type="checkbox"/>	3	GE3	Protected
<input type="checkbox"/>	4	GE4	Unprotected
<input type="checkbox"/>	5	GE5	Unprotected

2. GE1, 2 and 3 fail to communicate mutually like other non-isolated ports.

## 5.8 Storm Control

Storms generated via broadcast, unknown multicast and unicast messages are prevented as follows. These messages will be suppressed subject to packet rates respectively. The average rate of the messages received by monitoring interfaces will be

compared with the max threshold configured during an inspection interval. Configured storm policing will be performed at this interface if the average rate exceeds the max threshold.

When a L2 Ethernet interface receives the broadcast, unknown multicast or unicast messages, the device will forward them to other L2 interfaces in a same VLAN (Virtual Local Area Network) if the egress interface cannot be recognized according to destination MAC addresses. As a result, broadcast storm may occur to degrade device operation performance.

Three kinds of message flow can be controlled by storm policing characteristics to stay away from broadcast storms.

Instructions:

1. Click the “Port > Storm Control” in the navigation bar to configure the attributes related to storm policing such as mode as follows:

2. Select the appropriate port and “Edit” it by configuring the policing rates of broadcast, unknown multicast and unicast storms at each port.

Port Setting Table

Entry	Port	State	Broadcast		Unknown Multicast		Unknown Unicast		Action
			State	Rate (Kbps)	State	Rate (Kbps)	State	Rate (Kbps)	
1	GE1	Disabled	Disabled	10000	Disabled	10000	Disabled	10000	Drop
2	GE2	Disabled	Disabled	10000	Disabled	10000	Disabled	10000	Drop
3	GE3	Disabled	Disabled	10000	Disabled	10000	Disabled	10000	Drop
4	GE4	Disabled	Disabled	10000	Disabled	10000	Disabled	10000	Drop
5	GE5	Disabled	Disabled	10000	Disabled	10000	Disabled	10000	Drop
6	GE6	Disabled	Disabled	10000	Disabled	10000	Disabled	10000	Drop
7	GE7	Disabled	Disabled	10000	Disabled	10000	Disabled	10000	Drop
8	GE8	Disabled	Disabled	10000	Disabled	10000	Disabled	10000	Drop

3. Configure info such as storm switch and rate, “Apply” and finish as follows:

### Edit Port Setting

Port	GE1-GE3
State	<input checked="" type="checkbox"/> Enable
Broadcast	<input checked="" type="checkbox"/> Enable <input type="text" value="10000"/> Kbps (16 - 1000000, default 10000)
Unknown Multicast	<input checked="" type="checkbox"/> Enable <input type="text" value="10000"/> Kbps (16 - 1000000, default 10000)
Unknown Unicast	<input checked="" type="checkbox"/> Enable <input type="text" value="10000"/> Kbps (16 - 1000000, default 10000)
Action	<input checked="" type="radio"/> Drop <input type="radio"/> Shutdown

## 5.9 Mirroring

Port Mirroring copies the message of a specified switch port to the destination port. The copied port is the Source Port, and the copying port is the Destination Port. Destination Port accesses to data inspection devices so that users can analyze the messages received to monitor network and troubleshoot as follows:

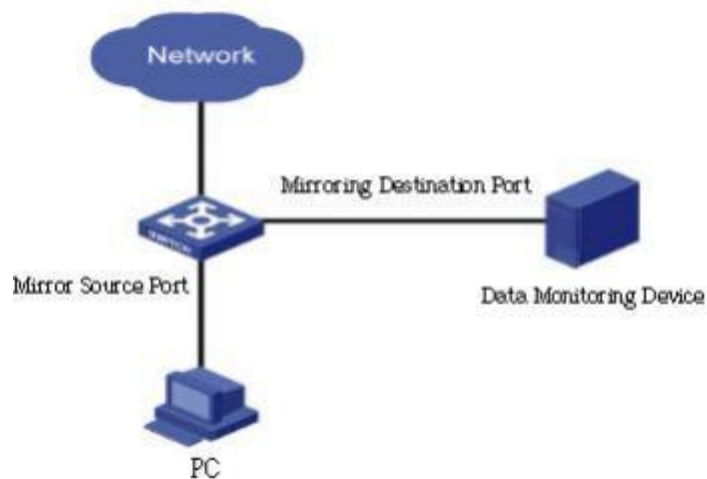

### Instance

PC1 and PC2 access Switch A through interface GE1 and GE2 respectively. Users intend to monitor the messages transmitted from PC2 to PC1.

### Instructions:

1. Click the "Port > Mirroring" in the navigation bar. 4 sets of flow mirroring rules can

be configured as follows:

### Mirroring Table

	Session ID	State	Monitor Port	Ingress Port	Egress Port
<input type="radio"/>	1	Disabled	---	---	---
<input type="radio"/>	2	Disabled	---	---	---
<input type="radio"/>	3	Disabled	---	---	---
<input type="radio"/>	4	Disabled	---	---	---

\*\*\* Allow the monitor port to send or receive normal packets

2. Select one session and “Edit” it in the mirroring group configuration interface:

### Edit Mirroring

<b>Session ID</b>	1	
<b>State</b>	<input checked="" type="checkbox"/> Enable	
<b>Monitor Port</b>	GE1	
	<input checked="" type="checkbox"/> Send or Receive Normal Packet	
<b>Ingress Port</b>	Available Port	Selected Port
	GE1 GE5 GE6 GE7 GE8 GE9 GE10 GE11	GE2 GE3 GE4
<b>Egress Port</b>	Available Port	Selected Port
	GE1 GE5 GE6 GE7 GE8 GE9 GE10 GE11	GE2 GE3 GE4

Interface data are as follows

Configuration	Description
---------------	-------------

Items	
Session ID	The switch has 4 session IDs by default.
State	The mirroring group can be enabled or not.
Monitor Port	Only one ordinary physical port can be selected, excluding link aggregation port and source port.
Ingress Port	Any message received will be mirrored to the destination port.
Egress Port	Any message transmitted will be mirrored to the destination port.

## 6 VLAN

VLAN is formulated not restricted to physical locations, which means the hosts in a same VLAN can be placed at will. As shown below, each VLAN, as a broadcast domain, divides a physical LAN into logical LANs. Hosts can exchange messages by means of traditional communication. For the hosts in different VLANs, the device such as router or L3 switch is a must.

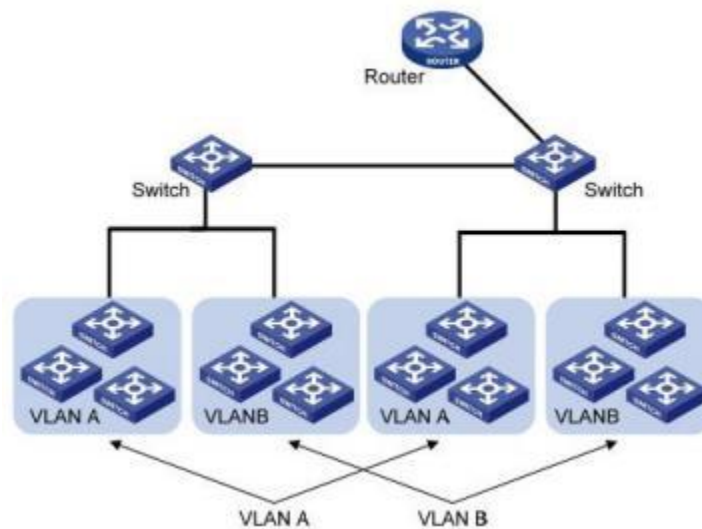

VLAN is superior to the traditional Ethernet in terms of:

- Broadcast domain coverage: the broadcast message in a LAN is limited in a VLAN to save the bandwidth and handle the network-related issues more efficiently.
- LAN security: VLAN hosts fail to communicate with each other since the messages are separated by the broadcast domain in the data link layer. They need a router or a Layer 3 switch for Layer 3 forwarding.
- Flexibility of creating a virtual working team: VLAN can create a virtual working team beyond the control of physical network. Users have access to the network without changing the configuration if their physical locations are moving within the scope. This management switch is compatible with VLAN types based on 802.1Q, protocols,

MAC, and ports. For default configuration, 802.1Q VLAN mode should be adopted. Port VLAN is divided subject to a switch's interface No. Network administrator gives each switch interface a different PVID, namely a port default VLAN. If a data frame without a VLAN tag flows into a switch interface with a PVID, it will be marked with the same PVID, or it will get rid of an additional tag even though the interface has a PVID.

- The solution to a VLAN frame depends on the interface type, which eases member definition but re-configures VLAN in case of member mobility.

## 6.1 VLAN

### 6.1.1 Create VALN

Instructions for creating a new VLAN:

1. Click the "VLAN > VLAN > Create VLAN" to select a name in the valid VLAN box, move it to the VLAN creating box on the right (up to 256 VLANs can be created). "Apply" and finish as follows:

**VLAN Table**

Showing  entries      Showing 1 to 1 of 1 entries     

VLAN	Name	Type	VLAN Interface State
<input type="radio"/> 1	default	Default	Disabled

2. The VLAN created will be displayed in the VLAN Table. Users can "Edit" the VLAN as follows:

### Edit VLAN Name

Name	VLAN0002
Apply	Close

Interface data are as follows.

Configuration Items	Description
VLAN ID	It is required to select an ID ranging from 1 to 4,094. For example, 1-3,5,7 and 9. LAN 1 is the default, which won't be repeated in another new VLAN.
Name	It is optional to modify the VLAN description as required.

## 6.1.2 VLAN Configuration

There are two methods. One is to add multiple ports under a single VLAN. The other is to add a port to multiple VLANs. They are configured according to different purposes.

Instructions for the first method to add the current port to a specified VLAN

1. Click the "VLAN > VLAN > VLAN Configuration" in the navigation bar, select the VLAN ID on the upper left, and then click the port info as follows:

### VLAN Configuration Table

VLAN

Entry	Port	Mode	Membership			PVID	Forbidden
1	GE1	Trunk	<input type="radio"/> Excluded	<input type="radio"/> Tagged	<input checked="" type="radio"/> Untagged	<input checked="" type="checkbox"/>	<input type="checkbox"/>
2	GE2	Trunk	<input type="radio"/> Excluded	<input type="radio"/> Tagged	<input checked="" type="radio"/> Untagged	<input checked="" type="checkbox"/>	<input type="checkbox"/>
3	GE3	Trunk	<input type="radio"/> Excluded	<input type="radio"/> Tagged	<input checked="" type="radio"/> Untagged	<input checked="" type="checkbox"/>	<input type="checkbox"/>
4	GE4	Trunk	<input type="radio"/> Excluded	<input type="radio"/> Tagged	<input checked="" type="radio"/> Untagged	<input checked="" type="checkbox"/>	<input type="checkbox"/>
5	GE5	Trunk	<input type="radio"/> Excluded	<input type="radio"/> Tagged	<input checked="" type="radio"/> Untagged	<input checked="" type="checkbox"/>	<input type="checkbox"/>
6	GE6	Trunk	<input type="radio"/> Excluded	<input type="radio"/> Tagged	<input checked="" type="radio"/> Untagged	<input checked="" type="checkbox"/>	<input type="checkbox"/>
7	GE7	Trunk	<input type="radio"/> Excluded	<input type="radio"/> Tagged	<input checked="" type="radio"/> Untagged	<input checked="" type="checkbox"/>	<input type="checkbox"/>
8	GE8	Trunk	<input type="radio"/> Excluded	<input type="radio"/> Tagged	<input checked="" type="radio"/> Untagged	<input checked="" type="checkbox"/>	<input type="checkbox"/>

Interface data are as follows.

Configuration Items	Description
VLAN	VLAN ID to be configured
Port	Port list

Mode	VLAN mode of port
Membership	Member roles at the VLAN port: Excluded: the port is out of this VLAN Tagged: the port is a tagged member of this VLAN Untagged: the port is an untagged member of this VLAN
PVID	Whether this VLAN is the port PVID
Forbidden	Whether the VLAN message is forbidden to be forwarded at this port

### 6.1.3 Membership

Instructions for the second method to add the current port to a specified VLAN

1. Click the “VLAN > VLAN > Membership” in the navigation bar, select the port to be configured and “Edit” to configure its attributes:

#### Membership Table

	Entry	Port	Mode	Administrative VLAN	Operational VLAN
<input type="radio"/>	1	GE1	Trunk	1UP	1UP
<input type="radio"/>	2	GE2	Trunk	1UP	1UP
<input type="radio"/>	3	GE3	Trunk	1UP	1UP
<input type="radio"/>	4	GE4	Trunk	1UP	1UP
<input type="radio"/>	5	GE5	Trunk	1UP	1UP
<input type="radio"/>	6	GE6	Trunk	1UP	1UP
<input type="radio"/>	7	GE7	Trunk	1UP	1UP

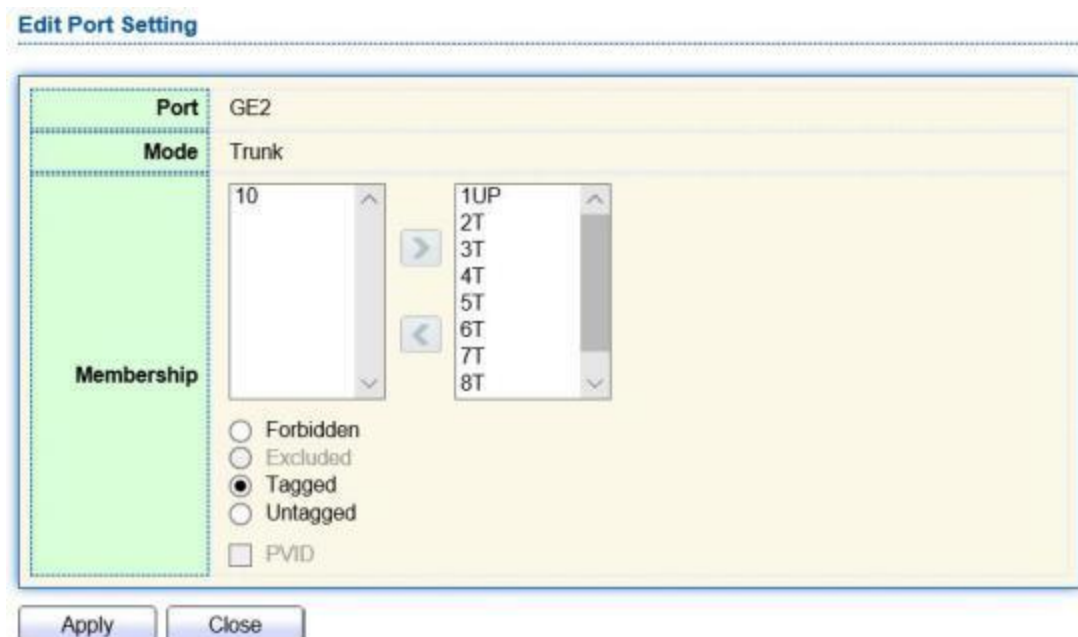

Interface data are as follows.

Configuration Items	Description
Port	Port list
Mode	VLAN mode of port
Membership	The port is the attribute of VLAN ID and VLAN: Forbidden: do not forward the VLAN message Excluded: the port out of the VLAN Tagged: The Tagged member of the VLAN Untagged: The Untagged member of the VLAN PVID: whether the VLAN is the port PVLAN

### 6.1.4 Port Setting

Trunk configuration. Connected with other switches, Trunk interfaces mainly connect trunk links to allow the VLAN frames to flow through. IEEE 802.1q is the encapsulation protocol of Trunk link and considers the formal standard for Virtual Bridged Local Area Networks. It changes the frame format of Ethernet by adding a 4-bit 802.1q Tag between the source MAC address field and the protocol field.

802.1q frame format

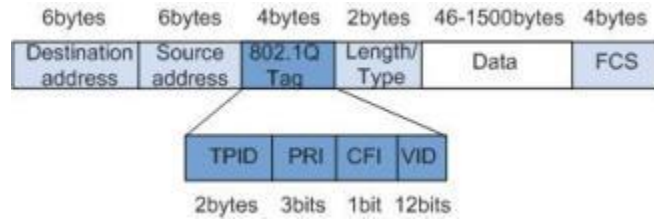

### Meanings of 802.1q tag fields

Field	Length	Name	Analysis
TPID	2 bytes	Tag Protocol Identifier to describe the frame type	It refers to the 802.1q Tag frame when the value is 0x8,100, which will be discarded if relevant equipment fails to receive it.
PRI	3 bits	Frame Priority	It ranges from 0 to 7, with the higher priority represented by larger number. Data frame with higher priority will be sent preferentially in case of switch congestion.
CFI	1 bit	Canonical Format Indicator to reveal whether the MAC address is classical or not.	MAC address is classical when CFI is 0 and non-classical when CFI is 1. It promotes the compatibility between Ethernet and token ring. CFI will be 0 in the Ethernet.
VID	12 bits	VLAN ID indicates the VLAN to which the frame belongs.	It ranges from 0 to 4,095, with 1 to 4,094 valid since 0 and 4,095 are the protocol retention values.

Packets sent by each switch supporting 802.1q protocol contain a VLAN ID to indicate the VLAN to which the switch belongs. Therefore, Ethernet frames are divided into two types as follows in a VLAN switching network:

- Tagged frame: it refers to the frame adding a 4-bit 802.1q Tag.
- Untagged frame: it refers to the original frame without a 4-bit 802.1q Tag.

Connected with other switches, Trunk interfaces mainly connect trunk links to allow the VLAN frames to flow through.

Instructions for trunk interface configuration:

1. Click the "VLAN > VLAN > Port Setting" in the navigation bar, select the port and "Edit" it to configure the attributes:

## Port Setting Table

<input type="checkbox"/>	Entry	Port	Mode	PVID	Accept Frame Type	Ingress Filtering	Uplink	TPID
<input type="checkbox"/>	1	GE1	Trunk	1	All	Enabled	Disabled	0x8100
<input type="checkbox"/>	2	GE2	Trunk	1	All	Enabled	Disabled	0x8100
<input type="checkbox"/>	3	GE3	Trunk	1	All	Enabled	Disabled	0x8100
<input type="checkbox"/>	4	GE4	Trunk	1	All	Enabled	Disabled	0x8100
<input type="checkbox"/>	5	GE5	Trunk	1	All	Enabled	Disabled	0x8100
<input type="checkbox"/>	6	GE6	Trunk	1	All	Enabled	Disabled	0x8100
<input type="checkbox"/>	7	GE7	Trunk	1	All	Enabled	Disabled	0x8100
<input type="checkbox"/>	8	GE8	Trunk	1	All	Enabled	Disabled	0x8100

### Edit Port Setting

<b>Port</b>	GE4-GE8
<b>Mode</b>	<input checked="" type="radio"/> Hybrid <input type="radio"/> Access <input type="radio"/> Trunk <input type="radio"/> Tunnel
<b>PVID</b>	<input type="text" value="1"/> (1 - 4094)
<b>Accept Frame Type</b>	<input checked="" type="radio"/> All <input type="radio"/> Tag Only <input type="radio"/> Untag Only
<b>Ingress Filtering</b>	<input checked="" type="checkbox"/> Enable
<b>Uplink</b>	<input type="checkbox"/> Enable
<b>TPID</b>	<input type="text"/>

Interface data are as follows.

Configuration Items	Description
Port	Port No. to be configured
Mode	VLAN mode of port Hybrid: port in this mode serves as the member of Tagged and Untagged ports of VLANs Access: port in this mode serves as the only member of VLAN Trunk: port in this mode serves as the only Untagged member of PVID and the Tagged member of VLANs Tunnel: Port Q-in-Q VLAN
PVID	Port native VLAN

Accept Frame Type	Message types received by ports All: all messages Tag Only: only Tagged messages will be received Untag Only: only Untagged messages will be received
Ingress Filtering	A switch to decide to filter VLAN messages excluded at the port
Uplink	Whether in uplink mode or not
TPID	Identification No. of VLAN Tag

## 6.2 Voice VLAN

Traditionally, ACL (Access Control List) will be applied to distinguish Voice Data and QoS (Quality of Service) will be used to ensure transmission quality, thus enhancing the priority. In order to simplify user configuration and facilitate voice flow management, Voice VLAN emerges. Enabled interface judges whether it is Voice Data flow or not according to the source MAC address field accessing the interface data flow. The message in the source MAC address is the Voice Data flow, which confirms to the OUI (Organizationally Unique Identifier) of the voice devices that are configured by the system. The interfaces receiving Voice Data flow will automatically transmit to Voice VLAN, thus simplifying user configuration and Voice Data management.

### OUI of Voice VLAN

OUI represents a MAC address field. Its address can be calculated based on the 48-bit MAC address and the corresponding bit of mask. The number of bits of ingress MAC address and matching OUI is determined by the length of the all "1"-bit in the mask. For example, if the MAC address is 1-1-1 and the mask is FFFF-FF00-0000, the result of execution and calculation of MAC address and corresponding mask, namely OUI, will be 0001-0000-0000.

If the first 24 bits of the ingress MAC address are matched with those of OUI, the enabled Voice VLAN interface identifies the data flow and the ingress device as the Voice Data flow and voice device respectively.

Voice VLAN is divided for user Voice Data flow. Voice VLANs are created to connect the interfaces linked with voice devices to transmit the Voice Data inside in a centralized way.

Voice Data and non-Voice Data often exist in the same network. Voice Data needs a higher priority than other business data during transmission to reduce the possible delay and packet loss.

1. Click the "VLAN > Voice VLAN > Property" in the navigation bar as follows.

<b>State</b>	<input type="checkbox"/> Enable
<b>VLAN</b>	None <input type="button" value="v"/>
<b>CoS / 802.1p Remarking</b>	<input type="checkbox"/> Enable 6 <input type="button" value="v"/>
<b>Aging Time</b>	1440 <input type="button" value="v"/> Min (30 - 65536, default 1440)

Interface data are as follows.

Configuration Items	Description
State	Check and enable the Voice VLAN
VLAN	Specify the VLAN ID added ranging from 1 to 4,094, e.g. 1-3, 5, 7 and 9, with VLAN 1 by default. Other VLANs must be added in an untagged way to the port needing links.
CoS / 802.1p Remarking	Whether to redefine the Voice VLAN message priority or not
Aging Time	Table aging time

### Port Setting Table

<input type="checkbox"/>	Entry	Port	State	Mode	QoS Policy
<input type="checkbox"/>	1	GE1	Disabled	Auto	Voice Packet
<input type="checkbox"/>	2	GE2	Disabled	Auto	Voice Packet
<input type="checkbox"/>	3	GE3	Disabled	Auto	Voice Packet
<input type="checkbox"/>	4	GE4	Disabled	Auto	Voice Packet
<input type="checkbox"/>	5	GE5	Disabled	Auto	Voice Packet
<input type="checkbox"/>	6	GE6	Disabled	Auto	Voice Packet
<input type="checkbox"/>	7	GE7	Disabled	Auto	Voice Packet

### Edit Port Setting

<b>Port</b>	GE1
<b>State</b>	<input type="checkbox"/> Enable
<b>Mode</b>	<input checked="" type="radio"/> Auto <input type="radio"/> Manual
<b>QoS Policy</b>	<input checked="" type="radio"/> Voice Packet <input type="radio"/> All

Interface data are as follows.

Configuration Items	Description
Port	Enabled Voice VLAN port
State	Check and enable the Voice VLAN
Mode	Voice VLAN port can be operated in auto mode and manual mode.
QoS Policy	Select the message to be affected by QoS

- Click the “VLAN > Voice VLAN > Voice OUI” in the navigation bar to configure the address segment of OUI of Voice VLAN as follows:

### Voice OUI Table

Showing  entries      Showing 1 to 8 of 8 entries     

<input type="checkbox"/>	OUI	Description
<input type="checkbox"/>	00 E0:BB	3COM
<input type="checkbox"/>	00 03:6B	Cisco
<input type="checkbox"/>	00 E0:75	Veritel
<input type="checkbox"/>	00:D0:1E	Pingtel
<input type="checkbox"/>	00 01:E3	Siemens
<input type="checkbox"/>	00 60:B9	NEC/Philips
<input type="checkbox"/>	00 0F:E2	H3C
<input type="checkbox"/>	00 09:6E	Avaya

### Add Voice OUI

<b>OUI</b>	<input type="text"/> .. <input type="text"/> .. <input type="text"/>
<b>Description</b>	<input type="text"/>

3. Fill in corresponding configuration items.
4. "Apply" and finish as follows.

### Voice OUI Table

Showing  entries      Showing 1 to 9 of 9 entries     

<input type="checkbox"/>	OUI	Description
<input type="checkbox"/>	00:E0:BB	3COM
<input type="checkbox"/>	00:03:6B	Cisco
<input type="checkbox"/>	00:E0:75	Veritel
<input type="checkbox"/>	00:D0:1E	Pingtel
<input type="checkbox"/>	00:01:E3	Siemens
<input type="checkbox"/>	00:60:B9	NEC/Philips
<input type="checkbox"/>	00:0F:E2	H3C
<input type="checkbox"/>	00:09:6E	Avaya
<input type="checkbox"/>	98:00:36	H7650

For example, configure the Voice VLAN in manual mode so that the ports accessing IP telephony can ingress/egress the Voice VLAN and transmit voice flow within it. Create VLAN2 to operate Voice VLAN securely, which allows only Voice Data to flow through. IP telephony transmits Untagged voice flow to GE1, the ingress Trunk port. Users must customize an OUI (0011-2231-05e1) and configure the Voice VLAN networking diagram in automatic mode.

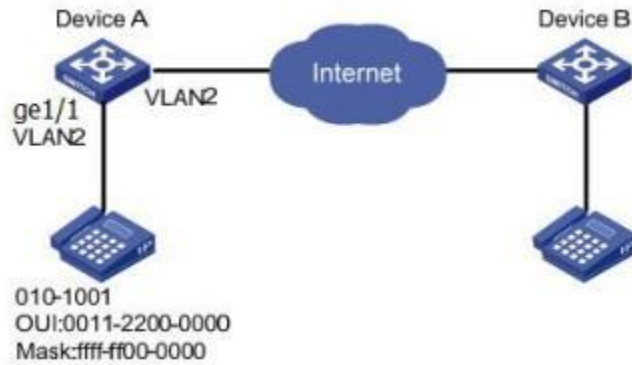

Instructions:

1. Create a VLAN to recognize the VLANs where employees belong. Click the “VLAN > VLAN > Create VLAN” in the navigation bar to add VLAN 2 to the VLAN list on the right. “Apply” and finish:

Apply

### VLAN Table

Showing  entries      Showing 1 to 2 of 2 entries     

VLAN	Name	Type	VLAN Interface State
<input type="radio"/> 1	default	Default	Disabled
<input type="radio"/> 2	VLAN0002	Static	Disabled

2. Configure the Ethernet interface GE1 of Switch A in Hybrid mode. Click the “VLAN > VLAN > Port Setting” in the navigation bar, “Edit” GE1 in Hybrid mode:

### Port Setting Table

Entry	Port	Mode	PVID	Accept Frame Type	Ingress Filtering	Uplink	TPID
<input type="checkbox"/> 1	GE1	Hybrid	1	All	Enabled	Disabled	0x8100

- Click the “VLAN > Voice VLAN > Voice OUI” in the navigation bar to configure and add the range of OUI MAC address, and enter the first 24 bits of MAC address of voice device: 00:11:22. “Apply” and finish as follows:

**Voice OUI Table**

Showing  entries      Showing 1 to 1 of 1 entries

<input type="checkbox"/>	OUI	Description
<input type="checkbox"/>	00:11:22	aaa

- Enable the Voice VLAN of port GE1. Click the “VLAN > Voice VLAN > Property” in the navigation bar to enable the global configuration, select VLAN2. Select port GE1 in the configuration list, “Edit” and enable the auto mode. “Apply” and finish as follows:

<b>State</b>	<input checked="" type="checkbox"/> Enable
<b>VLAN</b>	VLAN0002
<b>CoS / 802.1p Remarking</b>	<input type="checkbox"/> Enable 6
<b>Ageing Time</b>	1440      Min (30 - 65536, default 1440)

**Port Setting Table**

<input type="checkbox"/>	Entry	Port	State	Mode	QoS Policy
<input type="checkbox"/>	1	GE1	Enabled	Auto	Voice Packet
<input type="checkbox"/>	2	GE2	Disabled	Auto	Voice Packet

 **Note:**

- With the auto mode enabled, ports will forward Voice VLAN messages even though there is no port in VLAN2.

## 6.3 Protocol VLAN

Protocol VLAN distributes different VLAN IDs according to the protocol (family) type

and encapsulation format of the messages received by the interfaces.

Administrators should prepare the mapping scheme between the protocol domain of Ethernet frame and VLAN ID which will be added if untagged frames are received. Strength: Such division method will enhance the management and maintenance by binding the network services and VLANs. Shortcomings: Initial configuration of the mapping relation scheme is necessary. Address formats of protocols should be analyzed and converted, thus leading to a lower speed due to many resources consumed.

Instructions:

1. Click the “VLAN > Protocol VLAN > Protocol Group” in the navigation bar as follows:

**Protocol Group Table**

Showing  entries      Showing 1 to 1 of 1 entries     

<input type="checkbox"/>	Group ID	Frame Type	Protocol Value
<input type="checkbox"/>	1	Ethernet_II	0x8888

---

**Add Protocol Group**

<b>Group ID</b>	<input type="text" value="2"/>
<b>Frame Type</b>	<input type="text" value="Ethernet_II"/>
<b>Protocol Value</b>	0x <input type="text" value=""/> (0x600 ~ 0xFFFFE)

Interface data are as follows.

Configuration Items	Description
Group ID	Protocol VLAN Group
Frame Type	Frame types: Ether2, LLC, RFC 1042
Protocol Value	It ranges from 0x600 to 0xFFFFE

2. Fill in corresponding configuration items.
3. “Apply” and finish.

**Protocol Group Table**

Showing  entries      Showing 1 to 2 of 2 entries     

<input type="checkbox"/>	Group ID	Frame Type	Protocol Value
<input type="checkbox"/>	1	Ethernet_II	0x8888
<input type="checkbox"/>	2	RFC_1042	0x8889

- Click the “VLAN > Protocol VLAN > Group Binding” in the navigation bar to bind the protocol No., port No. and VLAN ID, to bring the configuration into effect as follows:

**Group Binding Table**

Showing  entries      Showing 1 to 1 of 1 entries

<input type="checkbox"/>	Port	Group ID	VLAN
<input type="checkbox"/>	GE1	1	10

 Description:

Configure the matching protocols IPv4 and IPv6, as well as the ARP protocol.

For example, PC1 and 3 can access mutually, with IPv4 communication protocol binding with VLAN10. PC2 and 4 can access mutually, with IPv6 communication protocol binding with VLAN20.

Networking diagram of protocol VLAN division

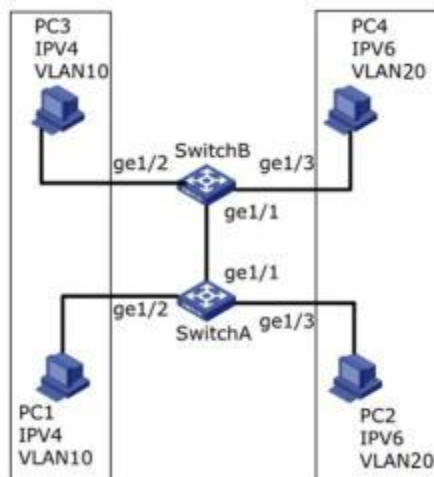

Instructions:

- Create a VLAN to recognize the VLANs where employees belong. Click the “VLAN > VLAN > Create VLAN”, add the VLAN10 and 20 to the VLAN Creating List on the right, “Apply” and finish:

**VLAN**

Available VLAN

- VLAN 2
- VLAN 3
- VLAN 4
- VLAN 5
- VLAN 6
- VLAN 7
- VLAN 8
- VLAN 9

Created VLAN

- VLAN 1
- VLAN 10
- VLAN 20

Apply

### VLAN Table

Showing All entries      Showing 1 to 3 of 3 entries

VLAN	Name	Type	VLAN Interface State
<input type="radio"/> 1	default	Default	Disabled
<input type="radio"/> 10	VLAN0010	Static	Disabled
<input type="radio"/> 20	VLAN0020	Static	Disabled

First Previous 1 Next Last

Edit Delete

2. Configure GE2 and GE3 interfaces of Switch A in Hybrid mode. Click the “VLAN > VLAN > Port Setting”, “Edit” the interfaces in Hybrid mode:

### Port Setting Table

Q

Entry	Port	Mode	PVID	Accept Frame Type	Ingress Filtering	Uplink	TPID
<input type="checkbox"/> 1	GE1	Trunk	1	All	Enabled	Disabled	0x8100
<input type="checkbox"/> 2	GE2	Hybrid	1	All	Enabled	Disabled	0x8100
<input type="checkbox"/> 3	GE3	Hybrid	1	All	Enabled	Disabled	0x8100
<input type="checkbox"/> 4	GE4	Trunk	1	All	Enabled	Disabled	0x8100
<input type="checkbox"/> 5	GE5	Trunk	1	All	Enabled	Disabled	0x8100

3. Add the Untagged GE2 and GE3 to VLAN10 and VLAN20 respectively. Click the “VLAN > VLAN > VLAN Configuration”, drop down the list to choose VLAN10 and the Untagged GE2 port. Following the same steps, add the untagged GE3 to VLAN20 as follows:

### VLAN Configuration Table

VLAN VLAN0010

Q

Entry	Port	Mode	Membership	PVID	Forbidden
1	GE1	Trunk	<input checked="" type="radio"/> Excluded <input type="radio"/> Tagged <input type="radio"/> Untagged	<input type="checkbox"/>	<input type="checkbox"/>
2	GE2	Hybrid	<input type="radio"/> Excluded <input type="radio"/> Tagged <input checked="" type="radio"/> Untagged	<input type="checkbox"/>	<input type="checkbox"/>
3	GE3	Hybrid	<input checked="" type="radio"/> Excluded <input type="radio"/> Tagged <input type="radio"/> Untagged	<input type="checkbox"/>	<input type="checkbox"/>

### VLAN Configuration Table

VLAN VLAN0020

Entry	Port	Mode	Membership			PVID	Forbidden
1	GE1	Trunk	<input checked="" type="radio"/> Excluded	<input type="radio"/> Tagged	<input type="radio"/> Untagged	<input type="checkbox"/>	<input type="checkbox"/>
2	GE2	Hybrid	<input checked="" type="radio"/> Excluded	<input type="radio"/> Tagged	<input type="radio"/> Untagged	<input type="checkbox"/>	<input type="checkbox"/>
3	GE3	Hybrid	<input type="radio"/> Excluded	<input type="radio"/> Tagged	<input checked="" type="radio"/> Untagged	<input type="checkbox"/>	<input type="checkbox"/>
4	GE4	Trunk	<input checked="" type="radio"/> Excluded	<input type="radio"/> Tagged	<input type="radio"/> Untagged	<input type="checkbox"/>	<input type="checkbox"/>

- Add the Untagged GE2 and GE3 interfaces of Switch B to VLAN whose ports need links. Steps are like step 2 and 3.
- Add the Tagged GE1 interface of Switch A to VLAN10 and 20. Click the “VLAN > VLAN > VLAN Configuration”, drop down the list to select VLAN10 and the Tagged member of GE1. Configure VLAN20 similarly.

### VLAN Configuration Table

VLAN VLAN0010

Entry	Port	Mode	Membership			PVID	Forbidden
1	GE1	Trunk	<input type="radio"/> Excluded	<input checked="" type="radio"/> Tagged	<input type="radio"/> Untagged	<input type="checkbox"/>	<input type="checkbox"/>

### VLAN Configuration Table

VLAN VLAN0020

Entry	Port	Mode	Membership			PVID	Forbidden
1	GE1	Trunk	<input type="radio"/> Excluded	<input checked="" type="radio"/> Tagged	<input type="radio"/> Untagged	<input type="checkbox"/>	<input type="checkbox"/>

- Related protocol and VLAN. VLAN IDs are assigned according to the protocol (family) type and encapsulation format of the messages received by interfaces. Click the “VLAN > Protocol VLAN > Protocol Group” in the navigation bar to add 2 rules for protocol groups:

### Protocol Group Table

Showing All entries Showing 1 to 2 of 2 entries

<input type="checkbox"/>	Group ID	Frame Type	Protocol Value
<input type="checkbox"/>	1	Ethernet_II	0x0800
<input type="checkbox"/>	2	Ethernet_II	0x86DD

First Previous 1 Next Last

- Port, protocol group, and VLAN binding. Click the “VLAN > Protocol Group > Group

Binding”, “Add” to bind GE2 and binding group ID1 with VLAN10, and to bind GE3 and binding group ID2 with VLAN20:

**Group Binding Table**

Showing All entries      Showing 1 to 2 of 2 entries     

<input type="checkbox"/>	Port	Group ID	VLAN
<input type="checkbox"/>	GE2	1	10
<input type="checkbox"/>	GE3	2	20

            
         1       

## 6.4 MAC VLAN

MAC-based VLANs are divided subject to the MAC addresses in the network card. Administrators will prepare the mapping scheme between MAC address and VLAN ID which will be added if the switch receives untagged frames.

Strength: There is no need to re-configure VLAN when the physical location of a terminal user changes, which ensures user security and access flexibility. Shortcoming: It applies to the scene where network card and simple network environment are infrequently replaced, with members defined in advance.

Instructions:

1. Click the “VLAN > MAC VLAN > MAC Group” in the navigation bar, and “Add” a new MAC group as follows:

**MAC Group Table**

Showing All entries      Showing 1 to 1 of 1 entries     

<input type="checkbox"/>	Group ID	MAC Address	Mask
<input type="checkbox"/>	1	00:0A:5A:00:00:00	24

            
         1       

**Add MAC Group**

<b>Group ID</b>	<input type="text" value="2"/> (1 - 2147483647)
<b>MAC Address</b>	<input type="text" value="00:22:00:22:00:22"/>
<b>Mask</b>	<input type="text" value="48"/> × (9 - 48)

Interface data are as follows.

Configuration Items	Description
Group ID	MAC VLAN Group ID
MAC Address	The MAC address to be bound with VLAN
Mask	It indicates the MAC address port. Enter 48 if it is an exact match. Others should be consistent with the masks of IP addresses.

For example, a company with high info security requirements allows its PCs only to access the internal network. As is shown, switch GE1 connects the uplink ports of Switch A while its downstream ports connect PC1, 2 and 3. As a result, PC1, 2 and 3 can access the internal network through Switch A and Switch, while other PCs can't.

Configuration logic: following steps are used to divide the VLAN based on MAC address.

1. Create a relevant VLAN.
2. Add Ethernet interfaces to the VLAN in a correct way.
3. Connect the VLAN with the MAC addresses of PC1, 2 and 3.

Data preparation: following data should be prepared for the configuration instance:

- Set GE1 PVID of 100 on the switch.
- Set GE1 to access VLAN10 in the Untagged way on the switch.
- Set GE2 to access VLAN10 in the Tagged way on the switch.
- Set the Switch A interface by default, namely all interfaces will be added to VLAN1 in an Untagged way.
- Connect the MAC addresses of PC1, 2 and 3 with VLAN10.

Draw a networking diagram for VLAN division based on MAC addresses:

Instructions:

1. Create a VLAN to recognize the VLANs where employees belong. Click the "VLAN > VLAN > Create VLAN" in the navigation bar, add VLAN10 to the VLAN Creating List on the right, "Apply" and finish as follows:

### VLAN Table

Showing All entries      Showing 1 to 3 of 3 entries     

VLAN	Name	Type	VLAN Interface State
1	default	Default	Disabled
10	VLAN0010	Static	Disabled
100	VLAN0100	Static	Disabled

First Previous 1 Next Last

Edit Delete

- Configure Switch's GE1 in Hybrid mode with PVID of 100 to serve as an Untagged member of VLAN10. Configure GE2 in Trunk mode to serve as a Tagged member of VLAN10.

#### Port Setting Table

<input type="checkbox"/>	Entry	Port	Mode	PVID	Accept Frame Type	Ingress Filtering	Uplink	TPID
<input type="checkbox"/>	1	GE1	Hybrid	100	All	Enabled	Disabled	0x8100
<input type="checkbox"/>	2	GE2	Trunk	1	All	Enabled	Disabled	0x8100

#### Membership Table

<input type="radio"/>	Entry	Port	Mode	Administrative VLAN	Operational VLAN
<input type="radio"/>	1	GE1	Hybrid	1U, 10U, 100P	1U, 10U, 100P
<input type="radio"/>	2	GE2	Trunk	1UP, 10T	1UP, 10T
<input type="radio"/>	3	GE3	Trunk	1UP	1UP

- Configure the Switch A's interfaces by default, namely all interfaces access VLAN1 in an Untagged way. Connect the MAC addresses of PC1, 2 and 3 with VLAN10. Click the "VLAN > MAC VLAN > MAC Group" in the navigation bar, enter the MAC addresses of PC1 (0022-0022-0022), PC2 (0033-0033-0033) and PC3 (0044-0044-0044), with the mask of 48-bit exact match as follows:

#### MAC Group Table

Showing  entries      Showing 1 to 3 of 3 entries

<input type="checkbox"/>	Group ID	MAC Address	Mask
<input type="checkbox"/>	1	00:22:00:22:00:22	48
<input type="checkbox"/>	2	00:33:00:33:00:33	48
<input type="checkbox"/>	3	00:44:00:44:00:44	48

- Click the "VLAN > MAC VLAN > Group Binding" in the navigation bar, "Add" to select the Hybrid port only, MAC group ID to be bound, and specified VLAN ID. "Apply" and finish:

**MAC Group Table**

Showing  entries      Showing 1 to 3 of 3 entries     

<input type="checkbox"/>	Group ID	MAC Address	Mask
<input type="checkbox"/>	1	00:22:00:22:00:22	48
<input type="checkbox"/>	2	00:33:00:33:00:33	48
<input type="checkbox"/>	3	00:44:00:44:00:44	48

5. Configuration verification

Only PC1, 2 and 3 have access to the internal network.

## 6.5 Surveillance VLAN

Surveillance VLAN is mainly used for video stream packets. In order to ensure the priority of such packets in the transmission process, it is higher than ordinary packets

Instructions:

1. Click the “VLAN > Surveillance VLAN > Property” in the navigation bar as follows.

<b>State</b>	<input type="checkbox"/> Enable
<b>VLAN</b>	<input type="text" value="None"/>
<b>CoS / 802.1p Remarking</b>	<input type="checkbox"/> Enable <input type="text" value="6"/>
<b>Aging Time</b>	<input type="text" value="1440"/> Min (30 - 65536, default 1440)

Configuration Items	Description
State	Check and enable the Surveillance VLAN
VLAN	Specify the VLAN ID added ranging from 1 to 4,094, e.g. 1-3, 5, 7 and 9, with VLAN 1 by default. Other VLANs must be added in an untagged way to the port needing links.
CoS / 802.1p Remarking	Whether to redefine the Voice VLAN message priority or not
Aging Time	Table aging time

## Port Setting Table

<input type="checkbox"/>	Entry	Port	State	Mode	QoS Policy
<input type="checkbox"/>	1	GE1	Disabled	Auto	Video Packet
<input type="checkbox"/>	2	GE2	Disabled	Auto	Video Packet
<input type="checkbox"/>	3	GE3	Disabled	Auto	Video Packet
<input type="checkbox"/>	4	GE4	Disabled	Auto	Video Packet
<input type="checkbox"/>	5	GE5	Disabled	Auto	Video Packet
<input type="checkbox"/>	6	GE6	Disabled	Auto	Video Packet
<input type="checkbox"/>	7	GE7	Disabled	Auto	Video Packet

### Edit Port Setting

<b>Port</b>	GE1-GE2
<b>State</b>	<input type="checkbox"/> Enable
<b>Mode</b>	<input checked="" type="radio"/> Auto <input type="radio"/> Manual
<b>QoS Policy</b>	<input checked="" type="radio"/> Video Packet <input type="radio"/> All

Interface data are as follows.

Configuration Items	Description
Port	Enabled Voice VLAN port
State	Check and enable the Surveillance VLAN
Mode	Surveillance VLAN port can be operated in auto mode and manual mode.
QoS Policy	Select the message to be affected by QoS

- Click the "VLAN > Surveillance VLAN > Surveillance OUI" in the navigation bar to configure the address segment of OUI of Surveillance VLAN as follows:

## Surveillance OUI Table

Showing  entries      Showing 0 to 0 of 0 entries     

<input type="checkbox"/>	OUI	Description
0 results found.		

## Add Voice OUI

<b>OUI</b>	<input type="text" value=""/> : <input type="text" value=""/> : <input type="text" value=""/>
<b>Description</b>	<input type="text" value=""/>

- Fill in corresponding configuration items.
- “Apply” and finish as follows.

## Surveillance OUI Table

Showing  entries      Showing 1 to 1 of 1 entries     

<input type="checkbox"/>	OUI	Description
<input type="checkbox"/>	98:00:36	H7650

## 6.6 GVRP

GVRP VLAN registration protocol is an application of general attribute registration protocol, which provides 802.1Q compatible VLAN pruning function and dynamic VLAN establishment on 802.1Q trunk port trunk port.

GVRP switches can exchange VLAN configuration information with each other, cut unnecessary broadcast and unknown unicast traffic, and create and manage VLAN dynamically on switches connected through 802.1Q trunk.

GID and GIP are used in GVRP, which provide the general state mechanism description and information dissemination mechanism for GARP based applications respectively. GVRP only runs on 802.1Q trunk links. GVRP cuts off the trunk link so that

only the active VLAN is transmitted on the trunk connection. Before GVRP adds a VLAN to the trunk line, it first receives the join information from the switch. GVRP update information and timer can be changed. The GVRP ports have a variety of operating modes to control how they tailor VLANs. GVRP can dynamically add and manage VLAN for VLAN database

GVRP supports the propagation of VLAN information between devices. In GVRP, the VLAN information of a switch can be configured manually, and all other switches in the network can dynamically understand the VLANs. The terminal node can access any switch and connect to the required VLAN. In order to use GVRP, a GVRP compatible network interface card (NIC) should be installed. GVRP compatible NIC can be configured to join the required VLAN, and then access to a GVRP enabled switch. The communication connection between NIC and switch is established, and VLAN connectivity is realized between NIC and switch.

### 6.6.1 Property

Global and port configuration

Instructions:

1. Click the “VLAN > GVRP > Property” in the navigation bar as follows.

The screenshot shows a configuration interface for GVRP. At the top, there is a 'State' section with a checkbox labeled 'Enable'. Below this is a green header for 'Operational Timeout'. Underneath, there are three rows, each with a label, a text input field, and a range description. The 'Join' row has a value of 20 and a range of 'cs (2 - 16375, default 20)'. The 'Leave' row has a value of 60 and a range of 'cs (45 - 32760, default 60)'. The 'LeaveAll' row has a value of 1000 and a range of 'cs (65 - 32765, default 1000)'. At the bottom left of the configuration area is an 'Apply' button.

Interface data are as follows.

Configuration Items	Description
State	The GVRP feature is globally enabled by setting
Join	A value in the range of 2-16375cs, i.e. in units of one hundredth of a second. The default value is 20cs.
leave	a value in the range of 45-32760cs, i.e. in units of one hundredth of a second. The default is 60cs.
LeaveAll	a value in the range of 65-32765cs, i.e. in units of one hundredth of a second. The default is 1000cs.

- Click the “VLAN > GVRP > Property” in the navigation bar, select the port and “Edit” to enter the configuration interface as follows.

### Port Setting Table

Entry	Port	State	VLAN Creation	Registration
1	GE1	Disabled	Enabled	Normal
2	GE2	Disabled	Enabled	Normal
3	GE3	Disabled	Enabled	Normal
4	GE4	Disabled	Enabled	Normal
5	GE5	Disabled	Enabled	Normal
6	GE6	Disabled	Enabled	Normal
7	GE7	Disabled	Enabled	Normal
8	GE8	Disabled	Enabled	Normal

### Edit Port Setting

Port	GE1-GE2
State	<input type="checkbox"/> Enable
VLAN Creation	<input checked="" type="checkbox"/> Enable
Registration	<input checked="" type="radio"/> Normal <input type="radio"/> Fixed <input type="radio"/> Forbidden

Interface data are as follows.

Configuration Items	Description
Port	Port list
State	Enable or disable the GVRP function of the port
VLAN Creation	Enable or disable to create VLAN automatically
Registration	Three registration modes of GVRP Normal: Allow dynamic VLAN to register on the port, and send declaration messages of static VLAN and dynamic VLAN at the same time Fixed: Dynamic VLAN is not allowed to register on the port, only static VLAN declaration messages are sent Forbidden: Dynamic VLAN is not allowed to register on the port. At the same time, all VLANs except vlan1 on the port are deleted, and only vlan1 declaration message is sent

## 6.6.2 Membership

View GVRP dynamic member information

Instructions:

1. Click the “VLAN > GVRP > Membership” in the navigation bar as follows.

**Membership Table**

Showing  entries      Showing 0 to 0 of 0 entries     

VLAN	Member	Dynamic Member	Type
0 results found.			

## 6.6.3 Statistics

View port GVRP message statistics

Instructions:

1. Click the “VLAN > GVRP > Statistics” in the navigation bar as follows.

**Port**

**Statistics**

- All
- Receive
- Transmit
- Error

**Refresh Rate**

- None
- 5 sec
- 10 sec
- 30 sec

Receive	
Join empty	0
Empty	0
Leave Empty	0
Join In	0
Leave In	0
Leave All	0

## 7 MAC Address Table

Ethernet switches are mainly innovated to forward according to the purposes in the data link layer. That is, MAC address will transmit the messages to corresponding ports according to the purposes. MAC address forwarding table is a L2 table illustrating MAC addresses and forwarding ports, which is the basis of fast forwarding of L2 messages.

MAC address forwarding table contains following data:

- Destination MAC Address
- VLAN ID belonging to port
- Forwarding ingress No. of this device

There are two message forwarding types according to MAC address table info:

- Unicast mode: the switch directly transmits the messages from the table's egress when MAC address forwarding table contains corresponding entries with the destination MAC address.
- Broadcast mode: When the switch receives the messages with the destination address full of F-bits, or there is no entry corresponding to the MAC destination address in the forwarding table, the switch will forward the messages to all ports excluding the receiving port in this way.

### 7.1 Dynamic Address

Aging time and table info of MAC addresses can be configured and checked on this page.

MAC address table needs constant updates to cater to network changes. It automatically generates entries that are limited by their lifetime (i.e. aging time). Those entries not refreshed after expiration will be deleted. The aging time of an entry will be recalculated if its record is refreshed before expiration.

Proper aging time helps to achieve the aging target of MAC address. Shortage of aging time may lead many switches broadcast to discover the packets of destination MAC addresses, thus influencing the switch performance.

Aging too long can cause the switch to save outdated MAC address entries, thus exhausting the forwarding resources and failing to update the forwarding table based on network changes.

The switch may remove valid MAC address table entries due to too short aging time, thus reducing forwarding efficiency. In general, the aging time recommended is 300 seconds by default.

Instructions for aging time setting:

1. Click the "MAC Address Table > Dynamic Address" in the navigation bar to the

configuration and view interface:

The screenshot shows a configuration page for MAC Aging Time. At the top, there is a field labeled "Aging Time" with the value "300" and a unit "Sec (10 - 630, default 300)". Below this is an "Apply" button. The main section is titled "Dynamic Address Table". It shows "Showing 10 entries" and "Showing 1 to 10 of 65 entries". A search box is present. The table below lists 10 entries with columns for checkboxes, VLAN, MAC Address, and Port. At the bottom of the table are navigation buttons: "First", "Previous", "1", "2", "3", "4", "5", "Next", and "Last". Below the table are "Refresh" and "Add Static Address" buttons.

<input type="checkbox"/>	VLAN	MAC Address	Port
<input type="checkbox"/>	1	00:0B:0E:0F:00:ED	GE3
<input type="checkbox"/>	1	00:CF:E0:52:B0:4F	GE3
<input type="checkbox"/>	1	00:CF:E0:52:B0:8B	GE3
<input type="checkbox"/>	1	00:E0:4C:00:53:35	GE3
<input type="checkbox"/>	1	00:E0:4C:2E:2C:B3	GE3
<input type="checkbox"/>	1	00:E0:4C:2E:2C:DD	GE7
<input type="checkbox"/>	1	00:E0:4C:2E:2D:4C	GE3
<input type="checkbox"/>	1	00:E0:4C:93:C3:00	GE3
<input type="checkbox"/>	1	00:E0:4D:36:99:E4	GE3
<input type="checkbox"/>	1	00:E0:66:70:A6:CB	GE3

Interface data are as follows

Configuration Items	Description
MAC Aging Time	Enter the aging time of MAC address

2. Fill in corresponding configuration items.
3. "Apply" and finish.

MAC Table stores the MAC address, VLAN No., Ingress/Egress info, etc. that are learned by switches. When forwarding data, it will fast locate the device egress in accordance with the destination MAC address and VLAN No. query table of Ethernet frames.

To check the MAC address table, see Section 3.3 of Chapter 3

## 7.2 Static Address

Static table is manually configured by users and distributed to each interface board, which won't age.

Instructions:

1. Click the “MAC Address Table > Static Address” as follows:

**Static Address Table**

Showing  entries      Showing 1 to 1 of 1 entries

<input type="checkbox"/>	VLAN	MAC Address	Port
<input type="checkbox"/>	1	00:00:11:11:22:22	GE3

---

**Add Static Address**

<b>MAC Address</b>	<input type="text" value="00:00:11:11:22:22"/>
<b>VLAN</b>	<input type="text" value="10"/> × (1 - 4094)
<b>Port</b>	<input type="text" value="GE1"/>

Interface data are as follows.

Configuration Items	Description
MAC	Required. Enter the new MAC address e.g.: HH:HH:HH:HH:HH:HH
VLAN	Required. Specify the VLAN ID
Port	Required. Select the interface type and enter the interface name Description: it must be the member port of the configured VLANs.

2. Fill in corresponding configuration items.
3. “Apply” and finish.

## 7.3 Filtering Address

The switch discards the matched data frame by configuration

Instructions:

1. Click the “MAC Address Table > Filtering Address” as follows:

### Filtering Address Table

Showing All entries      Showing 0 to 0 of 0 entries     

<input type="checkbox"/>	VLAN	MAC Address
0 results found.		

 
  
     
  
  
1  
  

### Add Filtering Address

MAC Address	<input type="text"/>
VLAN	<input type="text"/> (1 - 4094)

Interface data are as follows.

Configuration Items	Description
MAC Address	MAC address to be filtered
VLAN	VLAN of MAC address

## 7.4 Port Security Address

If the MAC address is set to secure Mac, the port only allows the data frames of the secure Mac to pass through forever, and the others will be discarded

Instructions:

1. Click the “MAC Address Table > Port Security Address” as follows:

### Port Security Address Table

Showing All entries      Showing 0 to 0 of 0 entries     

<input type="checkbox"/>	VLAN	MAC Address	Type	Port
0 results found.				

 
  
     
  
  
1

### Add Port Security Address

MAC Address	<input type="text"/>
VLAN	<input type="text"/> (1 - 4094)
Port	GE1 ▼

Apply Close

Interface data are as follows.

Configuration Items	Description
MAC Address	MAC address for security
VLAN	VLAN of MAC address
Port	Port ID that enables port security

## 8 Spanning Tree

Redundant links are often used for link backup and network reliability in the Ethernet switching network. However, such links will generate loops on the switching network, leading to broadcast storm, unstable MAC address list and other faults, thus worsening users' communication quality, or even interrupting the communication. As a result, STP (Spanning Tree Protocol) appears.

Same with the development of other protocols, from the original STP defined in IEEE 802.1D, to RSTP (Rapid Spanning Tree Protocol) defined in IEEE 802.1W and to MSTP (Multiple Spanning Tree Protocol) defined in IEEE 802.1S, STP keeps upgrading.

MSTP is compatible with RSTP and STP while RSTP is compatible with STP. The contrast among these 3 protocols is shown in the table.

The contrast among 3 protocols

STP	Characteristic	Application
STP	A tree rid of loops as the solution to broadcast storms and redundant backups. It converges slowly.	All VLANs can be shared without discrimination in user or business flow.
RSTP	A tree rid of loops as the solution to broadcast storms and redundant backups. It converges rapidly.	
MSTP	A tree rid of loops as the solution to broadcast storms and redundant backups.	Distinguish the user and business flow for load sharing.

	It converges rapidly. Spanning trees balance the load among VLANs. Flow of different VLANs will be forwarded subject to paths.	Different VLANs forward the flow through separate spanning trees.
--	---	---

After STP is deployed, the following objectives can be achieved by calculating the loops with topology:

- Loop elimination: eliminate possible communication loops by blocking redundant links.
- Link backups: activate redundant links to restore network connectivity if the active path fails.

## 8.1 Property

Configure STP global parameters. In specific network environment, STP parameters of some devices must be adjusted to achieve the best performance.

Instructions:

1. Click the “Spanning Tree > Property” in the navigation bar as follows:

<b>State</b>	<input type="checkbox"/> Enable
<b>Operation Mode</b>	<input type="radio"/> STP <input checked="" type="radio"/> RSTP <input type="radio"/> MSTP
<b>Path Cost</b>	<input checked="" type="radio"/> Long <input type="radio"/> Short
<b>BPDU Handling</b>	<input type="radio"/> Filtering <input checked="" type="radio"/> Flooding
<b>Priority</b>	<input type="text" value="32768"/> (0 - 61440, default 32768)
<b>Hello Time</b>	<input type="text" value="2"/> Sec (1 - 10, default 2)
<b>Max Age</b>	<input type="text" value="20"/> Sec (6 - 40, default 20)
<b>Forward Delay</b>	<input type="text" value="15"/> Sec (4 - 30, default 15)
<b>Tx Hold Count</b>	<input type="text" value="6"/> (1 - 10, default 6)
<b>Region Name</b>	<input type="text" value="1C:2A:A3:00:00:8F"/>
<b>Revision</b>	<input type="text" value="0"/> (0 - 65535, default 0)
<b>Max Hop</b>	<input type="text" value="20"/> (1 - 40, default 20)

Interface data are as follows.

Configuration Items	Description
---------------------	-------------

State	It is checked by default to enable the spanning tree on behalf of switches.
Operation Mode	3 modes are available, namely STP, RSTP and MSTP.
Path Cost	In Long mode and Short mode
BPDU Handling	The method to handle the BPDU messages received by the device
Priority	Port priority
Hello Time	Intervals between Hello messages
Max Age	Max aging time
Forward Delay	Forward delay time
Tx Hold Count	Specify the Tx-hold-count used to limit the maximum numbers of packets transmission per second
Region Name	MST domain name. Switch master board sets the MAC address by default. Together with the VLAN mapping table of MST domain and the revision level of MSTP, switch domain name will jointly determine the domain to which it belongs.
Revision	The MSTP revision number
Max Hop	Specify the number of hops in an MSTP region before the BPDU is discarded

2. Fill in corresponding configuration items.
3. “Apply” and finish.

## 8.2 Port Setting

In specific network environment, STP parameters of some devices need to be adjusted for the best performance.

1. Click the “Spanning Tree > Port Setting” in the navigation bar, select the port and “Edit” to configure its attributes:

Port Setting Table

Entry	Port	State	Path Cost	Priority	BPDU Filter	BPDU Guard	Operational Edge	Operational Point-to-Point	Port Role	Port State	Designated Bridge	Designated Port ID	Designated Cost
1	GE1	Enabled	20000	128	Disabled	Disabled	Disabled	Disabled	Disabled	Disabled	0-00:00:00:00:00:00	128-1	20000
2	GE2	Enabled	20000	128	Disabled	Disabled	Disabled	Disabled	Disabled	Disabled	0-00:00:00:00:00:00	128-2	20000
3	GE3	Enabled	20000	128	Disabled	Disabled	Disabled	Enabled	Disabled	Forwarding	0-00:00:00:00:00:00	128-3	20000
4	GE4	Enabled	20000	128	Disabled	Disabled	Disabled	Disabled	Disabled	Disabled	0-00:00:00:00:00:00	128-4	20000
5	GE5	Enabled	20000	128	Disabled	Disabled	Disabled	Disabled	Disabled	Disabled	0-00:00:00:00:00:00	128-5	20000
6	GE6	Enabled	20000	128	Disabled	Disabled	Disabled	Disabled	Disabled	Disabled	0-00:00:00:00:00:00	128-6	20000
7	GE7	Enabled	20000	128	Disabled	Disabled	Disabled	Enabled	Disabled	Forwarding	0-00:00:00:00:00:00	128-7	20000

**Edit Port Setting**

<b>Port</b>	GE1
<b>State</b>	<input checked="" type="checkbox"/> Enable
<b>Path Cost</b>	<input type="text" value="0"/> (0 - 200000000) (0 = Auto)
<b>Priority</b>	128
<b>Edge Port</b>	<input type="checkbox"/> Enable
<b>BPDU Filter</b>	<input type="checkbox"/> Enable
<b>BPDU Guard</b>	<input type="checkbox"/> Enable
<b>Point-to-Point</b>	<input checked="" type="radio"/> Auto <input type="radio"/> Enable <input type="radio"/> Disable
<b>Port State</b>	Disabled
<b>Designated Bridge</b>	0-00:00:00:00:00:00
<b>Designated Port ID</b>	128-1
<b>Designated Cost</b>	20000
<b>Operational Edge</b>	False
<b>Operational Point-to-Point</b>	False

Apply Close

Interface data are as follows.

Configuration Items	Description
Port	The port No. to configure attributes
State	Enable STP or not
Path Cost	Enter the path cost value of the interface Use IEEE 802.1t Standard with the value ranging from 0 to 200,000,000
Priority	<p>Select the port priority with smaller value representing higher priority.</p> <p>Interface priority affects the role of the interface on the specified MSTI. On different MSTI, users can configure the priorities for a same interface. As a result, flow of different VLANs can be forwarded along physical links to achieve VLAN load sharing.</p> <p>Description: MSTP will recalculate the interface role and migrate its state when its priority changes.</p>
Edge Port	Rather than another switch or network segment, the edge port should be connected directly to user terminals. It can quickly transit to the forward state since topology changes create no loops. An edge port under configuration can be quickly transitioned to

	forward state by STP. To achieve this, it is recommended that Ethernet ports connected directly to user terminals should be configured as edge ports.
BPDU Filter	Enable BPDU Filter or not
BPDU Guard	Enable BPDU Guard or not. Unchecked by default. If BPDU Guard is enabled, the device will shut down the interfaces receiving BPDU and notify the NMS. Such interfaces can only be restored manually by network administrators.
Point-to-Point	Select enabled, shutdown, and auto modes. Auto mode: it indicates the connect state between the default auto inspection and point-to-point links. Enabled mode: it indicates the specific port is connected to the point-to-point links. Shutdown mode: it indicates the specific port fails to connect the point-to-point links.

2. Fill in corresponding configuration items.
3. “Apply” and finish.

### 8.3 MST Instance

A switching network is divided into multiple domains by MSTP, with independent spanning trees formed within each domain. Each Spanning Tree is called a MSTI (Multiple Spanning Tree Instance), and each domain is called a MST Region: Multiple Spanning Tree Region).

#### Description:

An instance is a group of VLANs that reduces communication cost and resource utilization rate. Each instance, independently calculated with topology, can balance the load. VLANs with the same topology can be mapped to a same instance, and they are forwarded according to the port state in corresponding MSTP instances.

In simple terms, mapped to the specified MST instance, one or more VLANs are distributed to a spanning tree at a time.

#### Instructions:

1. Click the “Spanning Tree > MST Instance” in the navigation bar, “Edit” the selected spanning tree instances to be configured as follows:

## MST Instance Table

MSTI	Priority	Bridge Identifier	Designated Root Bridge	Root Port	Root Path Cost	Remaining Hop	VLAN
0	32768	32768-1C:2A:A3:00:00:8F	0-00:00:00:00:00:00	N/A	0	0	1-4094
1	32768	32768-1C:2A:A3:00:00:8F	0-00:00:00:00:00:00	N/A	0	0	
2	32768	32768-1C:2A:A3:00:00:8F	0-00:00:00:00:00:00	N/A	0	0	
3	32768	32768-1C:2A:A3:00:00:8F	0-00:00:00:00:00:00	N/A	0	0	
4	32768	32768-1C:2A:A3:00:00:8F	0-00:00:00:00:00:00	N/A	0	0	
5	32768	32768-1C:2A:A3:00:00:8F	0-00:00:00:00:00:00	N/A	0	0	
6	32768	32768-1C:2A:A3:00:00:8F	0-00:00:00:00:00:00	N/A	0	0	

## Edit MST Instance Setting

MSTI	0
Priority	32768 (0 - 61440, default 32768)
Bridge Identifier	32768-1C:2A:A3:00:00:8F
Designated Root Bridge	0-00:00:00:00:00:00
Root Port	
Root Path Cost	0
Remaining Hop	0

Interface data are as follows.

Configuration Items	Description
MSTI	Instance No. of spanning trees ranges from 0 to 15
VLAN	VLAN No. mapped from instances
Priority	Set the priority of a multiple of 4,096 for the specified instance, ranging from 0 to 65,535 with 32,768 as default.

- Fill in corresponding configuration items.
- “Apply” and finish as follows.

## 8.4 MST Port Setting

Instructions:

- Click the “Spanning Tree > MST Port Setting” in the navigation bar, check the port to be modified from the list of all ports of the device, “Edit” to enter the detailed configuration interface as follows:

### MST Port Setting Table

MSTI 0

Entry	Port	Path Cost	Priority	Port Role	Port State	Mode	Type	Designated Bridge	Designated Port ID	Designated Cost	Remaining Hop
1	GE1	20000	128	Disabled	Disabled	RSTP	Boundary	0-00:00:00:00:00:00	128-1	0	20
2	GE2	20000	128	Disabled	Disabled	RSTP	Boundary	0-00:00:00:00:00:00	128-2	0	20
3	GE3	20000	128	Disabled	Disabled	RSTP	Boundary	0-00:00:00:00:00:00	128-3	0	20
4	GE4	20000	128	Disabled	Disabled	RSTP	Boundary	0-00:00:00:00:00:00	128-4	0	20
5	GE5	20000	128	Disabled	Disabled	RSTP	Boundary	0-00:00:00:00:00:00	128-5	0	20
6	GE6	20000	128	Disabled	Disabled	RSTP	Boundary	0-00:00:00:00:00:00	128-6	0	20
7	GE7	20000	128	Disabled	Disabled	RSTP	Boundary	0-00:00:00:00:00:00	128-7	0	20
8	GE8	20000	128	Disabled	Forwarding	RSTP	Boundary	0-00:00:00:00:00:00	128-8	0	20
9	GE9	20000	128	Disabled	Disabled	RSTP	Boundary	0-00:00:00:00:00:00	128-9	0	20

### Edit MST Port Setting

MSTI 0

Port GE1-GE2

Path Cost  (0 - 200000000) (0 = Auto)

Priority

Port Role Disabled

Port State Disabled

Mode RSTP

Type Boundary

Designated Bridge 0-00:00:00:00:00:00

Designated Port ID 128-1

Designated Cost 20000

Remaining Hop 20

Interface data are as follows.

Configuration Items	Description
MSTI	Select the instance for configuration through the drop-down box in the upper left.
Port	Select the port to be configured by users
Path Cost	Enter the path cost value of the interface Use IEEE 802.1t Standard with the value ranging from 0 to 200,000,000
Priority	Select the port priority with smaller value representing higher priority. Interface priority affects the role of the interface on the specified MSTI. On different MSTI, users can configure the priorities for a same interface. As a result, flow of different VLANs can be forwarded along physical links to achieve VLAN load sharing. Description: MSTP will recalculate the interface role and migrate its state when its priority changes.

Port Role	3 types of root ports, namely specified port, backup port and disabled port.
Port State	Including 3 states, namely Discarding, Forwarding and Disabled
Mode	Current STP mode
Type	The port types in the instance contain boundary and internal ports

- Fill in corresponding configuration items.
- “Apply” and finish.

**Example of MSTP function configuration:**

Switch A, B, C and D all run MSTP which introduces instances to share the load of VLAN10 and 20. MSTP can set up the VLAN mapping table to associate VLANs with spanning tree instances, and to map VLAN10 from instance 1 and VLAN20 from instance 2.

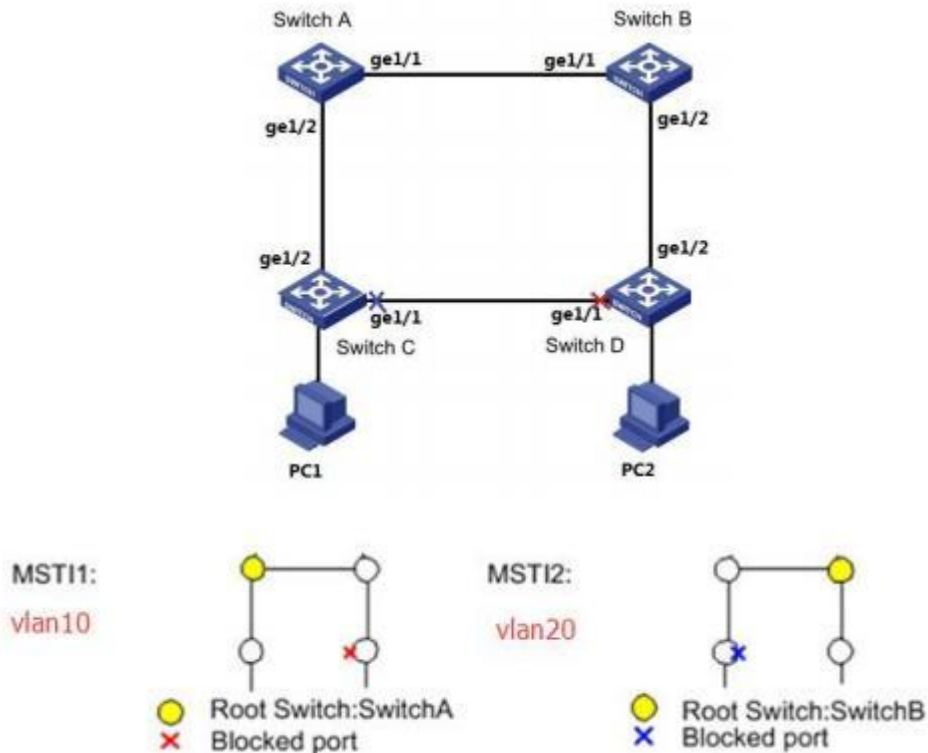

**Instructions:**

- Switch A, B, C and D create VLAN10 and 20 to configure the L2 forwarding function of the devices on the Ring. Click the “VLAN > VLAN > Create VLAN” in the navigation bar, fill in the corresponding configurations. “Apply” and finish as follows.

### VLAN Table

Showing All entries Showing 1 to 3 of 3 entries

VLAN	Name	Type	VLAN Interface State
<input type="radio"/> 1	default	Default	Disabled
<input type="radio"/> 10	VLAN0010	Static	Disabled
<input type="radio"/> 20	VLAN0020	Static	Disabled

2. VLANs are added to the switch ports ingress loops. Click the “VLAN > VLAN > Membership” in the navigation bar, select the ring port to be configured, move VLAN10 and 20 to the right box and mark them with “Tagged”. “Apply” and finish:

### Edit Port Setting

3. Click the “Spanning Tree > Property” in the navigation bar, and choose MSTP mode as follows:

<b>State</b>	<input checked="" type="checkbox"/> Enable
<b>Operation Mode</b>	<input type="radio"/> STP <input type="radio"/> RSTP <input checked="" type="radio"/> MSTP
<b>Path Cost</b>	<input checked="" type="radio"/> Long <input type="radio"/> Short
<b>BPDU Handling</b>	<input type="radio"/> Filtering <input checked="" type="radio"/> Flooding
<b>Priority</b>	<input type="text" value="32768"/> (0 - 61440, default 32768)
<b>Hello Time</b>	<input type="text" value="2"/> Sec (1 - 10, default 2)
<b>Max Age</b>	<input type="text" value="20"/> Sec (6 - 40, default 20)
<b>Forward Delay</b>	<input type="text" value="15"/> Sec (4 - 30, default 15)
<b>Tx Hold Count</b>	<input type="text" value="6"/> (1 - 10, default 6)
<b>Region Name</b>	<input type="text" value="1C:2A:A3:00:00:8F"/>
<b>Revision</b>	<input type="text" value="0"/> (0 - 65535, default 0)
<b>Max Hop</b>	<input type="text" value="20"/> (1 - 40, default 20)

- Configure the VLAN mapping between instance MSTI1 and MSTI2. Click the “Spanning Tree > MST Instance” to fill in corresponding parameters, and “Add” them as follows:

**MST Instance Table**

MSTI	Priority	Bridge Identifier	Designated Root Bridge	Root Port	Root Path Cost	Remaining Hop	VLAN
<input type="radio"/>	0	32768-1C:2A:A3:00:00:8F	0-00:00:00:00:00:00	N/A	0	0	1-9,11-19,21-4094
<input type="radio"/>	1	32768-1C:2A:A3:00:00:8F	0-00:00:00:00:00:00	N/A	0	0	10
<input type="radio"/>	2	32768-1C:2A:A3:00:00:8F	0-00:00:00:00:00:00	N/A	0	0	20
<input type="radio"/>	3	32768-1C:2A:A3:00:00:8F	0-00:00:00:00:00:00	N/A	0	0	

 **Note:**

- Set the priority of MSTI1 to 0 and MSTI2 to 4,096 before configuring Switch A.
  - Set the priority of MSTI1 to 4,096 and MSTI2 to 0 before configuring Switch B.
  - The priority must be a multiple of 4,096.
- Switch B serves as the root bridge of MSTI2 and the backup root bridge of MSTI1 in the domain. Please refer to 5 for instructions.
  - The tree-shaped network will eliminate loops.

## 8.5 Statistics

Instructions:

1. Click the “Spanning Tree > Statistics” in the navigation bar, entry port statistics as follows:

**Statistics Table**

Refresh Rate  sec

	Entry	Port	Receive BPDU			Transmit BPDU			
			Config	TCN	MSTP	Config	TCN	MSTP	
<input type="checkbox"/>	1	GE1	0	0	0	0	0	0	
<input type="checkbox"/>	2	GE2	0	0	0	0	0	0	
<input type="checkbox"/>	3	GE3	0	0	0	0	0	0	
<input type="checkbox"/>	4	GE4	0	0	0	0	0	0	
<input type="checkbox"/>	5	GE5	0	0	0	0	0	0	
<input type="checkbox"/>	6	GE6	0	0	0	0	0	0	
<input type="checkbox"/>	7	GE7	0	0	0	0	0	0	

## 9 Discovery

LLDP (Link Layer Discovery Protocol) is defined in IEEE 802.1ab. It is a standard L2 discovery method which integrates the info such as management addresses, device and interface identifications of local network devices and transmits to the neighbor devices. After receiving the info, they will save it in form of standard MIB (Management Information Base) for NMS query and link communication judgment.

It can also integrate the info and transmit to its own remote devices. The info received by the local network device will be kept in the form of MIB. The following shows how it works.

Block diagram of LLDP principles

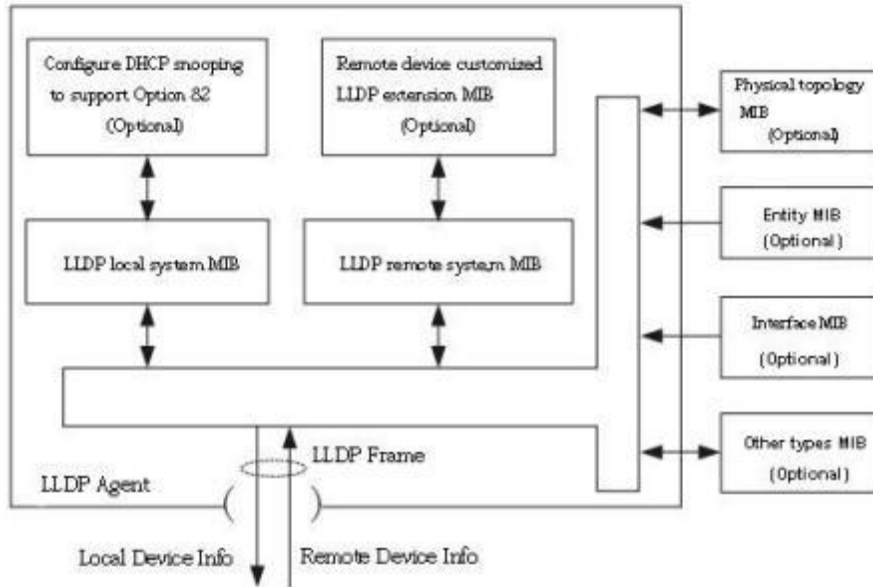

LLDP is realized based on:

- LLDP module updates its local system MIB, as well as the customized extension MIB, through the interaction between LLDP agent and MIBs of physical topology, entity, interface and other types.
- Encapsulate the info of local network device into LLDP frames and transmit to the remote device.
- Receive the LLDP frame sent by the remote device to update LLDP remote system MIB and customized extension MIB.
- Master the info of remote device such as connection interface and MAC address through the transmitting & receiving function of LLDP agent.
- The local system MIB stores local device info, including device and interface IDs, system name and description, interface description, network management address, etc.
- The remote system MIB stores local device info, including device and interface IDs, system name and description, interface description, network management address, etc.

Based on **LLDP**, **LLDP-MED** allows other units to expand. The info checked by network devices facilitates fault analysis and deepens the accurate understanding of network topology by management system.

## 9.1 LLDP

Instructions:

1. Click the “Discovery > LLDP > Property” in the navigation bar as follows.

The screenshot shows the LLDP configuration page. The 'LLDP' section is highlighted in green and contains the following settings:

- State:**  Enable
- LLDP Handling:**
  - Filtering
  - Bridging
  - Flooding
- TLV Advertise Interval:** 30 (Sec (5 - 32767, default 30))
- Hold Multiplier:** 4 (2 - 10, default 4)
- Reinitializing Delay:** 2 (Sec (1 - 10, default 2))
- Transmit Delay:** 2 (Sec (1 - 8191, default 2))

The 'LLDP-MED' section is also highlighted in green and contains the following setting:

- Fast Start Repeat Count:** 3 (1 - 10, default 3)

An 'Apply' button is located at the bottom of the configuration area.

Interface data are as follows.

Configuration Items	Description
State	Enable or disable the LLDP
LLDP Handling	LLDP messages will be processed by means of “Filtering”, “Bridging” and “Flooding” when disabling the LLDP.
TLV Advertise Interval	30s by default ranging from 5 to 32,768s.
Hold Multiplier	Transmission period product with 4 by default ranges from 2 to 10. Transmission period * product should be no more than 65,535.
Reinitializing Delay	2s by default ranging from:1 to 10s.
Transmit Delay	2s by default ranging from:1 to 8,191s.
Fast Start Repeat Count	3s by default of the LLDP-MED port ranging from 1 to 10s.

Ethernet message encapsulated with LLDPDU (LLDP Data Unit) are recognized as LLDP message. Each TLV is a unit of LLDPDU carried with specified info.

2. Fill in corresponding configuration items
3. “Apply” and finish.

## 9.2 Port Setting

Instructions

1. Click the “Discovery > LLDP > Port Setting” in the navigation bar as follows.

## Port Setting Table

<input type="checkbox"/>	Entry	Port	Mode	Selected TLV
<input type="checkbox"/>	1	GE1	Normal	802.1 PVID
<input type="checkbox"/>	2	GE2	Normal	802.1 PVID
<input type="checkbox"/>	3	GE3	Normal	802.1 PVID
<input type="checkbox"/>	4	GE4	Normal	802.1 PVID

Interface data are as follows.

Configuration Items	Description
Port	Port list
Mode	LLDP mode include: Transmit, Receive, Normal, Disable, the default is Normal Transmit: transmit LLDP messages only; Receive: receive LLDP messages only; Normal: transmit and receive LLDP messages; Disable: neither transmit nor receive LLDP messages.
Selected TLV	Info of selected TLV and VLAN

LLDP can work in 4 patterns: Transmit: transmit LLDP messages only; Receive: receive LLDP messages only; Normal: transmit and receive LLDP messages; Disable: neither transmit nor receive LLDP messages.

2. Check corresponding port and “Edit” the port configuration. “Apply” and finish as follows.

## Edit Port Setting

<b>Port</b>	GE1	
<b>Mode</b>	<input type="radio"/> Transmit <input type="radio"/> Receive <input checked="" type="radio"/> Normal <input type="radio"/> Disable	
<b>Optional TLV</b>	Available TLV Port Description System Name System Description System Capabilities 802.3 MAC-PHY	Selected TLV 802.1 PVID
<b>802.1 VLAN Name</b>	Available VLAN VLAN 1	Selected VLAN

Interface data are as follows.

Configuration Items	Description
Port	Port list
Mode	LLDP mode include: Transmit, Receive, Normal, Disable, the default is Normal Transmit: transmit LLDP messages only; Receive: receive LLDP messages only; Normal: transmit and receive LLDP messages; Disable: neither transmit nor receive LLDP messages.
Optional TLV	Select the info of TLV and VLAN
802.1 VLAN Name	Select the VLAN name

## 9.3 MED Network Policy

MED is based on IEEE 802.1ab. LLDP is the neighbor discovery protocol of IEEE, which can be extended by other organizations. Information identified from network devices, such as switches and wireless access points, can help with fault analysis and allow management systems to accurately understand the network topology.

### Instructions

1. Click the "Discovery > LLDP > MED Network Policy" in the navigation bar as follows.

## MED Network Policy Table

Showing **All** entries      Showing 0 to 0 of 0 entries     

Policy ID	Application	VLAN	VLAN Tag	Priority	DSCP
0 results found.					

                   **1**       

## Add MED Network Policy

Policy ID	<input type="text" value="1"/>
Application	<input type="text" value="Voice"/>
VLAN	<input type="text"/> Range (0 - 4095)
VLAN Tag	<input checked="" type="radio"/> Tagged <input type="radio"/> Untagged
Priority	<input type="text" value="0"/>
DSCP	<input type="text" value="0"/>

Interface data are as follows.

Configuration Items	Description
Policy ID	Policy ID number
Application	Configure and publish network policy TLV
VLAN	VLAN number
VLAN Tag	VLAN Mode, optional Tagged or Untagged
Priority	CoS for services
DSCP	DSCP for services

## 9.4 MED Port Setting

Instructions

1. Click the “Discovery > LLDP > MED Port Setting” in the navigation bar as follows.

## MED Port Setting Table

Entry	Port	State	Network Policy		Location	Inventory
			Active	Application		
<input type="checkbox"/>	1	GE1	Enabled	Yes	No	No
<input type="checkbox"/>	2	GE2	Enabled	Yes	No	No
<input type="checkbox"/>	3	GE3	Enabled	Yes	No	No
<input type="checkbox"/>	4	GE4	Enabled	Yes	No	No
<input type="checkbox"/>	5	GE5	Enabled	Yes	No	No
<input type="checkbox"/>	6	GE6	Enabled	Yes	No	No
<input type="checkbox"/>	7	GE7	Enabled	Yes	No	No

### Edit MED Port Setting

<b>Port</b>	GE1-GE2	
<b>State</b>	<input checked="" type="checkbox"/> Enable	
<b>Optional TLV</b>	Available TLV	Selected TLV
	<input type="text" value="Location"/> <input type="text" value="Inventory"/>	<input type="text" value="Network Policy"/>
<b>Network policy</b>	Available Policy	Selected Policy
	<input type="text"/>	<input type="text"/>
<b>Location</b>		
<b>Coordinate</b>	<input type="text"/>	(16 pairs of hexadecimal characters)
<b>Civic</b>	<input type="text"/>	(6 - 160 pairs of hexadecimal characters)
<b>ECS ELIN</b>	<input type="text"/>	(10 - 25 pairs of hexadecimal characters)
<input type="button" value="Apply"/> <input type="button" value="Close"/>		

Interface data are as follows.

Configuration Items	Description
Entry	Serial No. of MED port setting
Port	Port list
State	Port enable status

Network Policy	Configure and publish network policy TLV
Location	Configure and publish location TLV
Inventory	Configure and publish inventory TLV

## 9.5 Packet View

Instructions

1. Click the “Discovery > LLDP > Packet View” in the navigation bar as follows.

### Packet View Table

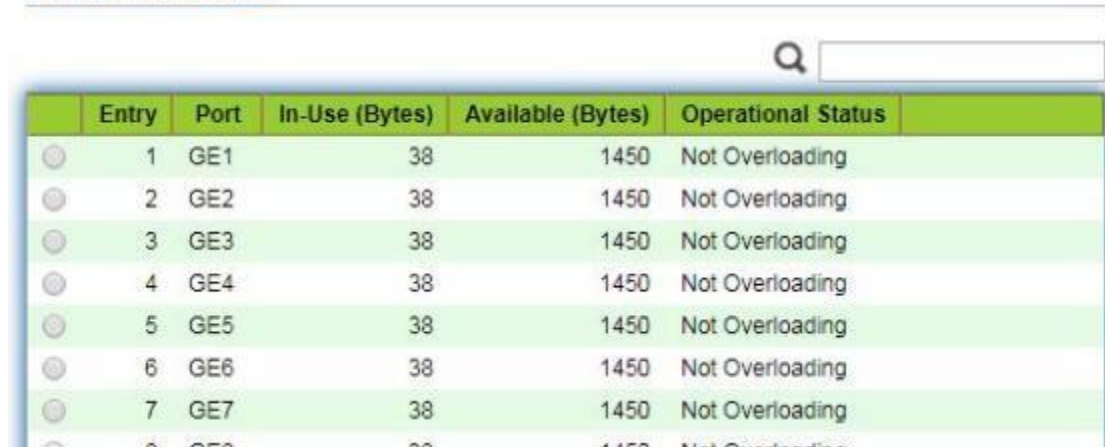

Entry	Port	In-Use (Bytes)	Available (Bytes)	Operational Status
1	GE1	38	1450	Not Overloading
2	GE2	38	1450	Not Overloading
3	GE3	38	1450	Not Overloading
4	GE4	38	1450	Not Overloading
5	GE5	38	1450	Not Overloading
6	GE6	38	1450	Not Overloading
7	GE7	38	1450	Not Overloading
8	GE8	38	1450	Not Overloading

## 9.6 Local Information

Instructions for device summary:

1. Click the “Discovery > LLDP > Local Information” in the navigation bar as follows.

### Device Summary



Chassis ID Subtype	MAC address
Chassis ID	00:E0:4C:00:00:00
System Name	Switch
System Description	G32410GSM
Supported Capabilities	Bridge, Router
Enabled Capabilities	Bridge, Router
Port ID Subtype	Local

Instructions for port status table:

2. Click the “Discovery > LLDP > Local Information” in the navigation bar as follows.

## Port Status Table

Q

Entry	Port	LLDP State	LLDP-MED State	
<input type="radio"/>	1	GE1	Normal	Enabled
<input type="radio"/>	2	GE2	Normal	Enabled
<input type="radio"/>	3	GE3	Normal	Enabled
<input type="radio"/>	4	GE4	Normal	Enabled
<input type="radio"/>	5	GE5	Normal	Enabled
<input type="radio"/>	6	GE6	Normal	Enabled

## 9.7 Neighbor

Instructions for LLDP neighbor displaying

1. Click the “Discovery > LLDP > Neighbor” in the navigation bar as follows.

Neighbor Table

Showing All entries Showing 1 to 1 of 1 entries Q

Local Port	Chassis ID Subtype	Chassis ID	Port ID Subtype	Port ID	System Name	Time to Live
<input type="checkbox"/>	GE9	MAC address	00 E0 41 00 00 02	Local	g13	118

Clear Refresh Detail First Previous 1 Next Last

## 9.8 Statistics

Instructions:

1. Click the “Discovery > LLDP > Statistics” in the navigation bar as follows.

## Global Statistics

Insertions	11
Deletions	7
Drops	0
AgeOuts	0

## Statistics Table

Q

Entry	Port	Transmit Frame		Receive Frame			Receive TLV		Neighbor Timeout
		Total	Total	Discard	Error	Discard	Unrecognized		
<input type="checkbox"/>	1	GE1	0	0	0	0	0	0	0
<input type="checkbox"/>	2	GE2	0	0	0	0	0	0	0
<input type="checkbox"/>	3	GE3	278	29	0	0	0	0	0
<input type="checkbox"/>	4	GE4	0	0	0	0	0	0	0
<input type="checkbox"/>	5	GE5	0	0	0	0	0	0	0
<input type="checkbox"/>	6	GE6	0	0	0	0	0	0	0

## 10 DHCP

### DHCP Server brief introduction

With the expansion of network scale and the improvement of network complexity, network configuration is becoming more and more complex. Computer location changes (such as portable computer or wireless network) and the number of computers exceeds the IP address that can be allocated.

Dynamic Host Configuration Protocol (DHCP) is developed to meet these requirements. The DHCP protocol works in the client / server mode. The DHCP client requests the configuration information from the DHCP server dynamically, and the DHCP server returns the corresponding configuration information according to the policy.

In a typical application of DHCP, it generally includes a DHCP server and multiple clients (such as PC and laptop), as shown in Figure 1-1.

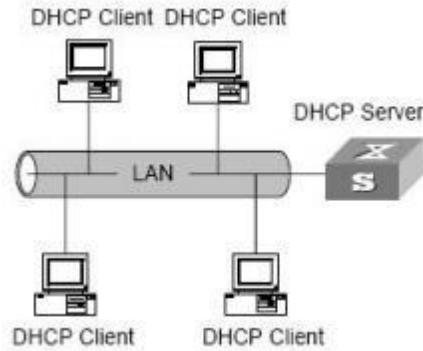

Figure 1-1. In a typical application of DHCP

## IP address assignment of DHCP

### IP address allocation strategy

According to the different needs of clients, DHCP provides three IP address allocation strategies

- Manual address assignment: the administrator binds the fixed IP address for a few specific clients (such as WWW server). Send the configured fixed IP address to the client through DHCP.
- Automatic address assignment: DHCP assigns IP addresses with unlimited lease term to clients.
- Dynamic address assignment: DHCP assigns IP address with valid period to client, and client needs to re-apply for address after expiration of service life. Most clients get this dynamic address assignment.

### Dynamic IP address acquisition process

The message interaction process between DHCP client and DHCP server is shown in Figure 2-1.

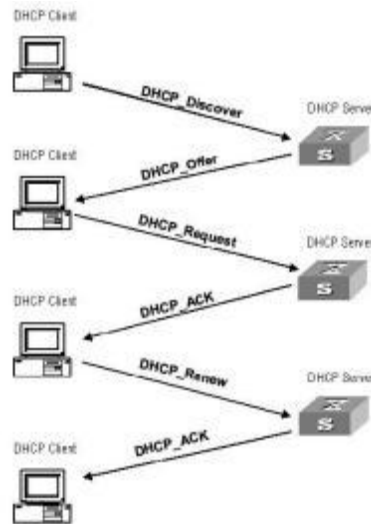

Figure 2-1. Interaction process

In order to obtain the legal dynamic IP address, the DHCP client interacts different information with the server at different stages. Generally, there are three modes as follows:

(1) DHCP client logs in to the network for the first time

When the DHCP client logs in to the network for the first time, it mainly establishes contact with the DHCP server through four stages

- The discovery phase: the stage in which the DHCP client looks for the DHCP server. The client sends the DHCP discover message in broadcast mode, and only the DHCP server will respond.
- The stage of providing IP address: that is, the stage when the DHCP server provides IP address. After receiving the DHCP discover message from the client, the DHCP server selects an unassigned IP address from the IP address pool and assigns it to the client, and sends the DHCP offer message containing the leased IP address and other settings to the client.
- The selection stage: the stage in which the DHCP client selects the IP address. If more than one DHCP server sends a DHCP offer message to the client, the client only accepts the first received DHCP offer message, and then responds to the DHCP request message by broadcasting to each DHCP server. The information contains the content of requesting IP address from the selected DHCP server.
- The confirmation stage: the stage in which the DHCP server confirms the IP address provided. When the DHCP server receives the DHCP request message answered by the DHCP client, it will send the dhcp-ack confirmation message containing the IP address and other settings provided by the client; otherwise, it will return the dhcp-nak message, indicating that the address cannot be assigned to the client. After receiving the dhcp-ack confirmation message

returned by the server, the client will send ARP (the destination address is the address to which it is assigned) in broadcast mode for address detection. If no response is received within the specified time, the client will use this address.

## (2) The DHCP client logs on to the network again

When the DHCP client logs in to the network again, it mainly establishes contact with the DHCP server through the following steps.

- After the DHCP client logs in to the network correctly for the first time and then logs in to the network again, it only needs to broadcast the DHCP request message containing the IP address assigned last time, and it is not necessary to send the DHCP discover message again.
- After receiving the DHCP request message, if the address requested by the client is not assigned, the dhcp-ack confirmation message will be returned to notify the DHCP client to continue using the original IP address.
- If the IP address cannot be assigned to the DHCP client (for example, it has been assigned to other clients), the DHCP server will return a dhcp-nak message. After receiving the message, the client sends the DHCP discover message again to request a new IP address.

## (3) DHCP client extends lease validity of IP address

The dynamic IP address assigned by the DHCP server to the client usually has a certain lease term. After the expiration, the server will take back the IP address. If the DHCP client wants to continue using the address, the IP lease needs to be updated.

In practice, the DHCP client sends a DHCP request message to the DHCP server by default when the IP address lease term reaches half to complete the IP lease update. If the IP address is valid, the DHCP server will respond to the dhcp-ack message to inform the DHCP client that a new lease has been obtained.

# 10.1 Property

DHCP global and static binding configuration

Instructions:

1. Click the “DHCP > Property” in the navigation bar as follows.

State	<input type="checkbox"/> Enable
Static Binding First	<input type="checkbox"/> Enable

Apply

### DHCP Port Setting Table

<input type="checkbox"/>	Entry	Port	State
<input type="checkbox"/>	1	GE1	Enabled
<input type="checkbox"/>	2	GE2	Disabled
<input type="checkbox"/>	3	GE3	Disabled
<input type="checkbox"/>	4	GE4	Disabled
<input type="checkbox"/>	5	GE5	Disabled
<input type="checkbox"/>	6	GE6	Disabled

Instructions for port DHCP configuration:

2. Click the “DHCP > Property”, and select the port and click “Edit” as follows.

#### Edit Port Setting

Port	GE1-GE2
State	<input checked="" type="checkbox"/> Enable

Apply      Close

 **Note:**

- Enable DHCP server or DHCP relay mode, port needs to enable this function

## 10.2 IP Pool Setting

DHCP IP pool configuration

Instructions:

1. Click the “DHCP > IP Pool Setting”, Click “Add” to add IP pool as follows.

**IP Pool Table**

Showing All entries      Showing 0 to 0 of 0 entries     

Pool	Section		Gateway	Mask	DNS Primary Server	DNS Second Server	Lease time
	Section	Start Address					
0 results found.							

**IP Pool Table**

<b>Pool</b>	<input type="text"/> (1 to 32 alphanumeric characters)
<b>Gateway</b>	<input type="text"/>
<b>Mask</b>	<input type="text"/>
<b>IP Address Section</b>	Section: <input type="text" value="1"/> Start Address: <input type="text"/> End Address: <input type="text"/>
<b>DNS Primary Server</b>	<input type="checkbox"/> Enable <input type="text"/>
<b>DNS Second Server</b>	<input type="checkbox"/> Enable <input type="text"/>
<b>Lease time</b>	<input type="text" value="1"/> Day <input type="text" value="00"/> Hour <input type="text" value="00"/> Minute



**Note:**

- The start address and end address cannot be configured or contain a gateway address

## 10.3 VLAN IF Address Group Setting

Server group configuration

Instructions:

1. Click the “DHCP > VLAN IF Address Group Setting”, enter the DHCP Server Group Table and click “Add” to configure the server group as follows.

## DHCP Server Group Table

Q

Group ID	Group IP Address	Bind VLAN Interface
0 results found.		

## DHCP Server Group Table

DHCP Server Group	<input type="text" value="1"/>
Group IP Address	<input type="text"/>

VLAN interface and server group binding configuration

Instructions:

1. Click the “DHCP > VLAN IF Address Group Setting”, enter the VLAN Interface Address Pool Table, select the interface and server group, and then click “Apply” as follows.

## Vlan Interface Address Pool Table

Interface	<input type="text" value="MGMT VLAN"/>
DHCP Server Group	<input type="text"/>

## 10.4 Client List

Client list information

Instructions:

1. Click the “DHCP > Client List”, enter DHCP Client list as follows.

**DHCP Client List**

Showing  entries      Showing 0 to 0 of 0 entries     

<input type="checkbox"/>	MAC Address Table	IPv4 Address	VLAN	Hostname
0 results found.				

## 10.5 Client Static Binding Table

Static IP address assignment configuration

Instructions:

1. Click the “DHCP > Client Static Binding Table”, enter Static Binding Table, and click “Add” as follows.

**Static Binding Table**

Showing  entries      Showing 0 to 0 of 0 entries     

<input type="checkbox"/>	MAC Address Table	IPv4 Address	VLAN	User Name
0 results found.				



**Note:**

- The IP configuration of static binding is required to be within the scope of IP address assignment.

## 11 Multicast

### 11.1 General

#### 11.1.1 Property

Instructions:

1. Click the “Multicast > General > Property” in the navigation bar as follows.

The screenshot shows a configuration interface for Multicast properties. It is divided into two main sections:

- Unknown Multicast Action:** Contains three radio button options: 'Flood' (selected), 'Drop', and 'Forward to Router Port'.
- Multicast Forward Method:** This section is further divided into two sub-sections:
  - IPv4:** Contains two radio button options: 'DMAC-VID' (selected) and 'DIP-VID'.
  - IPv6:** Contains two radio button options: 'DMAC-VID' (selected) and 'DIP-VID'.

At the bottom of the configuration area, there is an 'Apply' button.

### 11.1.2 Group Address

According to the previous request mode of multicast, the multicast router will copy and forward data to each VLAN containing receivers when users in different VLANs request the same multicast group, which wastes a great deal of bandwidth. IGMP Snooping configures multicast VLAN by connecting the different users of switch ports to a same multicast VLAN to receive multicast data. In this way, multicast flow can only be transmitted within a multicast VLAN, thus saving bandwidth. In addition, security and bandwidth are guaranteed because multicast VLANs are completely isolated from user VLANs.

#### Instructions

1. Click the “Multicast > Group Address”, “Add” a new static multicast item, and “Edit” the existing ones as follows:

The screenshot shows the 'Group Address Table' interface. At the top, there is a dropdown menu for 'IP Version' set to 'IPv4'. Below it, there are labels for 'Showing All entries' and 'Showing 0 to 0 of 0 entries'. A search box is located to the right. The main part of the interface is a table with the following columns: 'VLAN', 'Group Address', 'Member', 'Type', and 'Life (Sec)'. The table body is empty, with the text '0 results found.' centered below the header. At the bottom of the table, there are navigation buttons: 'First', 'Previous', '1', 'Next', and 'Last'. Below the table, there are four buttons: 'Add', 'Edit', 'Delete', and 'Refresh'.

### Add Group Address

Interface data are as follows.

Configuration Items	Description
VLAN	VLAN ID to which the multicast group belongs. Drop down to select an existing VLAN.
IP Version	Whether v4 or v6 is the version of multicast IP address
Multicast Address	Enter the multicast address
Member	Add multicast member(s)

- Fill in corresponding configuration items.
- “Apply” and finish as follows.

### Group Address Table

<input type="checkbox"/>	VLAN	Group Address	Member	Type	Life (Sec)
<input type="checkbox"/>	1	224.1.1.111	GE1-GE8	Static	

### 11.1.3 Router Port

Configure and view multicast router port

Instructions:

1. Click the “Multicast > General > Router Port” in the navigation bar as follows.

**Router Port Table**

IP Version

Showing  entries      Showing 0 to 0 of 0 entries     

<input type="checkbox"/>	VLAN	Member	Static Port	Forbidden Port	Life (Sec)
0 results found.					

### 11.1.4 Forward All

Configure and view multicast forward port

Instructions:

1. Click the “Multicast > General > Forward All” in the navigation bar as follows.

**Forward All Table**

IP Version

Showing  entries      Showing 0 to 0 of 0 entries     

<input type="checkbox"/>	VLAN	Static Port	Forbidden Port
0 results found.			

### 11.1.5 Throttling

Configure and view port multicast group restrictions

Instructions:

1. Click the “Multicast > General > Throttling” in the navigation bar as follows.

## Throttling Table

IP Version

<input type="checkbox"/>	Entry	Port	Max Group	Exceed Action
<input type="checkbox"/>	1	GE1	256	Deny
<input type="checkbox"/>	2	GE2	256	Deny
<input type="checkbox"/>	3	GE3	256	Deny
<input type="checkbox"/>	4	GE4	256	Deny
<input type="checkbox"/>	5	GE5	256	Deny
<input type="checkbox"/>	6	GE6	256	Deny

### 11.1.6 Filtering Profile

Configure and view port multicast filtering profile

Instructions:

1. Click the “Multicast > General > Filtering Profile” in the navigation bar as follows.

## Filtering Profile Table

IP Version

Showing  entries

Showing 0 to 0 of 0 entries

<input type="checkbox"/>	Profile ID	Start Address	End Address	Action
0 results found.				

Configure and view multicast filtering profile and port binding relationship

2. Click the “Multicast > General > Filtering Binding” in the navigation bar as follows.

## Filtering Binding Table

IP Version

<input type="checkbox"/>	Entry	Port	Profile ID
<input type="checkbox"/>	1	GE1	
<input type="checkbox"/>	2	GE2	
<input type="checkbox"/>	3	GE3	
<input type="checkbox"/>	4	GE4	
<input type="checkbox"/>	5	GE5	
<input type="checkbox"/>	6	GE6	

## 11.2 IGMP Snooping

IGMP Snooping (Internet Group Management Protocol Snooping) is a constraint mechanism on L2 devices to manage and control multicast groups.

By analyzing the IGMP messages received, L2 devices establish a mapping between ports and MAC multicast addresses and forward the multicast data accordingly.

As shown below, multicast data are transmitted on L2 without IGMP snooping. When IGMP snooping runs, known multicast group data are transmitted to specified receivers while unknown multicast data are still on Layer 2.

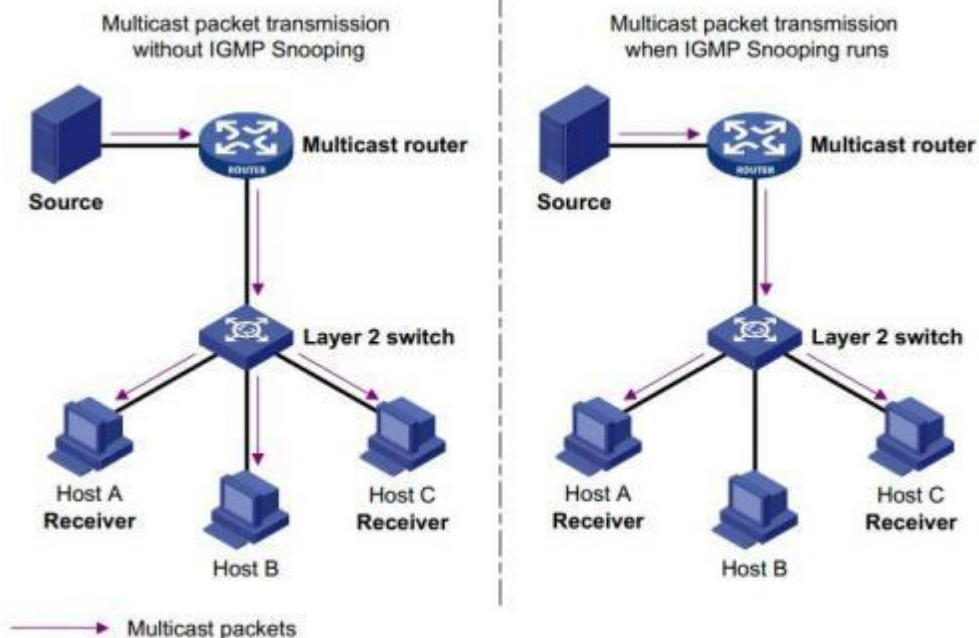

## 11.2.1 Property

IGMP Snooping is on the L2 switch between the multicast routers and the user hosts, applicable to deploy IPv4 networks. It is configured in a VLAN to snoop the IGMP/MLD messages transmitted between routers and hosts, and to establish a L2 forwarding table for multicast data, in order to manage and control the multicast data forwarding in L2 network.

Global IGMP Snooping function should be enabled since it is disabled by default.

Instructions:

1. Click the “Multicast > IGMP Snooping > Property”, select the VLAN to be configured from the created VLAN info, and “Edit” the details as follows:

State  Enable

Version  IGMPv2  IGMPv3

Report Suppression  Enable

Apply

**VLAN Setting Table**

	VLAN	Operational Status	Router Port Auto Learn	Query Robustness	Query Interval	Query Max Response Interval	Last Member Query Counter	Last Member Query Interval	Immediate Leave
<input type="checkbox"/>	1	Disabled	Enabled	2	125	10	2	1	Disabled
<input type="checkbox"/>	10	Disabled	Enabled	2	125	10	2	1	Disabled
<input type="checkbox"/>	20	Disabled	Enabled	2	125	10	2	1	Disabled

Edit

## Edit VLAN Setting

<b>VLAN</b>	20
<b>State</b>	<input type="checkbox"/> Enable
<b>Router Port Auto Learn</b>	<input checked="" type="checkbox"/> Enable
<b>Immediate leave</b>	<input type="checkbox"/> Enable
<b>Query Robustness</b>	<input type="text" value="2"/> (1 - 7, default 2)
<b>Query Interval</b>	<input type="text" value="125"/> Sec (30 - 18000, default 125)
<b>Query Max Response Interval</b>	<input type="text" value="10"/> Sec (5 - 20, default 10)
<b>Last Member Query Counter</b>	<input type="text" value="2"/> (1 - 7, default 2)
<b>Last Member Query Interval</b>	<input type="text" value="1"/> Sec (1 - 25, default 1)
<b>Operational Status</b>	
<b>Status</b>	Disabled
<b>Query Robustness</b>	2
<b>Query Interval</b>	125 (Sec)
<b>Query Max Response Interval</b>	10 (Sec)
<b>Last Member Query Counter</b>	2
<b>Last Member Query Interval</b>	1 (Sec)

Interface data are as follows.

Configuration Items	Description
VLAN	VLAN ID to be configured
State	Enable or disable the IGMP Snooping in this VLAN
Router Port Auto Learn	Enable or disable route port automatic learning
Immediate leave	Multicast members leave quickly
Query Robustness	The Robustness Variable allows tuning for the expected packet loss on a network
Query Interval	The interval between message queries
Query Max Response Interval	Timeout (over the max response time) of a query message
Last Member Query Counter	Max number of queries for a specified group
Last Member Query Interval	The interval between message queries for a specified group

2. Fill in corresponding configuration items.
3. “Apply” and finish.

### 11.2.2 Querier

Configure and view IGMP snooping Querier

Instructions:

1. Click the “Multicast > IGMP Snooping > Querier” in the navigation bar as follows.



Interface data are as follows.

Configuration Items	Description
VLAN	Multicast VLAN
State	Enable or disable IGMP snooping querier
Operational Status	IGMP snooping querier running status
Version	Version for querier
Querier Address	Multicast address for querier

### 11.2.3 Statistics

Configure and view IGMP snooping statistics

Instructions:

1. Click the “Multicast > IGMP Snooping > statistics” in the navigation bar as follows.

Receive Packet	
Total	0
Valid	0
InValid	0
Other	0
Leave	0
Report	0
General Query	0
Special Group Query	0
Source-specific Group Query	0
Transmit Packet	
Leave	0
Report	0
General Query	0
Special Group Query	0
Source-specific Group Query	0

### 11.3 MLD Snooping

MLD snooping is the abbreviation of multicast Listener Discovery snooping. It is an IPv6 Multicast constraint mechanism running on layer 2 devices, which is used to manage and control IPv6 Multicast Groups.

The second layer device running MLD snooping establishes a mapping relationship between port and MAC multicast address by analyzing the received MLD message, and forwards IPv6 multicast data according to the mapping relationship

As shown in the figure below, when the layer 2 device does not run MLD snooping, the IPv6 multicast data packets are broadcast at layer 2; when the layer 2 device runs MLD snooping, the multicast data packets of known IPv6 Multicast groups will not be broadcast at layer 2, but will be multicast to the designated receivers at layer 2.

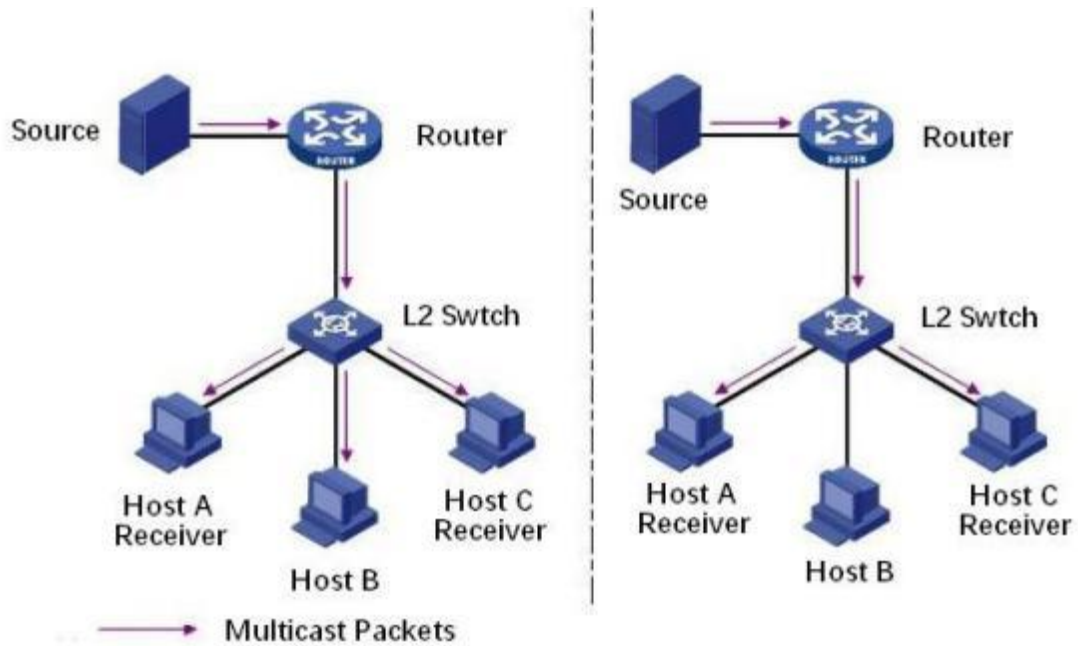

MLD snooping can only forward information to the receivers in need through layer 2 multicast, which can bring the following benefits:

- Reduce the broadcast packets in the layer 2 network and save the network bandwidth;
- Enhance the security of IPv6 Multicast information;
- It is convenient to charge each host separately.

### 11.3.1 Property

Global MLD Snooping function should be enabled since it is disabled by default.

Instructions:

1. Click the “Multicast > MLD Snooping > Property”, select the VLAN to be configured from the created VLAN info, and “Edit” the details as follows:

State:  Enable

Version:  MLDv1  MLDv2

Report Suppression:  Enable

**VLAN Setting Table**

VLAN	Operational Status	Router Port Auto Learn	Query Robustness	Query Interval	Query Max Response Interval	Last Member Query Counter	Last Member Query Interval	Immediate Leave
1	Disabled	Enabled	2	125	10	2	1	Disabled

## Edit VLAN Setting

<b>VLAN</b>	1
<b>State</b>	<input type="checkbox"/> Enable
<b>Router Port Auto Learn</b>	<input checked="" type="checkbox"/> Enable
<b>Immediate leave</b>	<input type="checkbox"/> Enable
<b>Query Robustness</b>	<input type="text" value="2"/> (1 - 7, default 2)
<b>Query Interval</b>	<input type="text" value="125"/> Sec (30 - 18000, default 125)
<b>Query Max Response Interval</b>	<input type="text" value="10"/> Sec (5 - 20, default 10)
<b>Last Member Query Counter</b>	<input type="text" value="2"/> (1 - 7, default 2)
<b>Last Member Query Interval</b>	<input type="text" value="1"/> Sec (1 - 25, default 1)
<b>Operational Status</b>	
<b>Status</b>	Disabled
<b>Query Robustness</b>	2
<b>Query Interval</b>	125 (Sec)
<b>Query Max Response Interval</b>	10 (Sec)
<b>Last Member Query Counter</b>	2
<b>Last Member Query Interval</b>	1 (Sec)

Interface data are as follows.

Configuration Items	Description
VLAN	VLAN ID to be configured
State	Enable or disable the IGMP Snooping in this VLAN
Router Port Auto Learn	Enable or disable route port automatic learning
Immediate leave	Multicast members leave quickly
Query Robustness	The Robustness Variable allows tuning for the expected packet loss on a network
Query Interval	The interval between message queries
Query Max Response Interval	Timeout (over the max response time) of a query message
Last Member Query Counter	Max number of queries for a specified group
Last Member Query Interval	The interval between message queries for a specified group

2. Fill in corresponding configuration items.
3. “Apply” and finish.

### 11.3.2 Statistics

Configure and view MLD snooping statistics

Instructions:

1. Click the “Multicast > MLD Snooping > statistics” in the navigation bar as follows.

Receive Packet	
Total	0
Valid	0
InValid	0
Other	0
Leave	0
Report	0
General Query	0
Special Group Query	0
Source-specific Group Query	0
Transmit Packet	
Leave	0
Report	0
General Query	0
Special Group Query	0
Source-specific Group Query	0

## 11.4 MVR

In order to solve the problem of multicast traffic broadcast based on VLAN in layer 2 network, we use IGMP snooping protocol to control the receiver, that is, only the receiver can receive the multicast traffic normally.

However, IGMP snooping can only effectively control the traffic of the same

multicast VLAN, but not the cross VLAN traffic. As a result, the efficiency of multiple replication of the same multicast in different VLANs still exists. In order to solve the flooding problem of cross VLAN, we adopt the dedicated multicast VLAN of multicast source traffic, as shown in the figure below

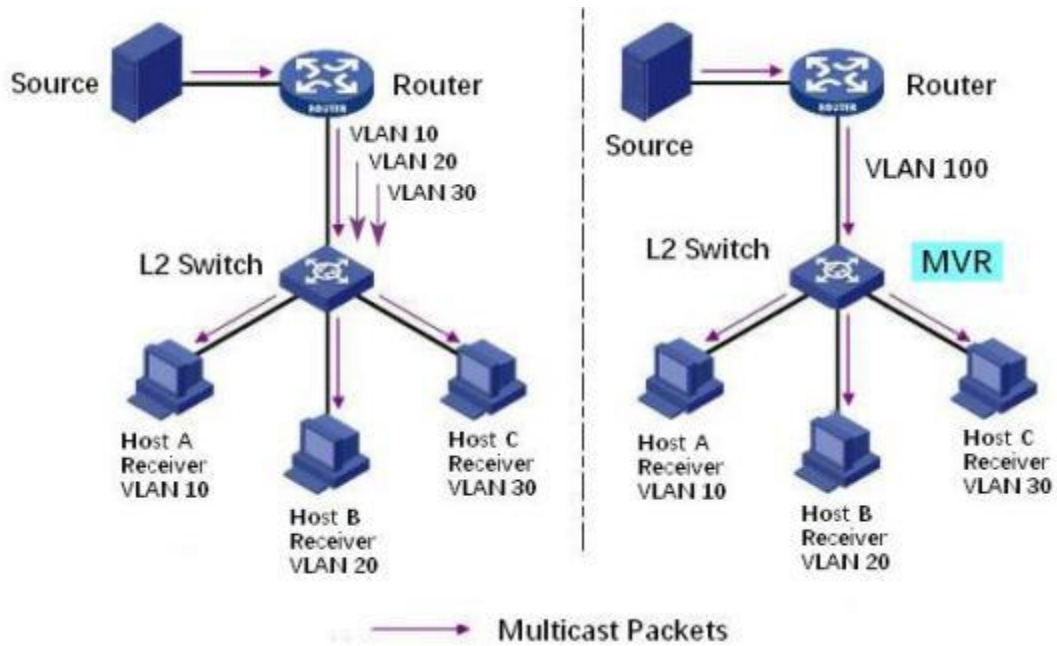

### 11.4.1 Property

Global MVR function should be enabled since it is disabled by default.

Instructions:

1. Click the “Multicast > MVR > Property”, enter the MVR global configuration interface as follows:

The screenshot shows a configuration window for MVR. It contains the following elements:

- State:** A checkbox labeled 'Enable' which is currently unchecked.
- VLAN:** A dropdown menu showing '1'.
- Mode:** Two radio buttons: 'Compatible' (selected) and 'Dynamic'.
- Group Start:** A text input field containing '0.0.0.0'.
- Group Count:** A text input field containing '1', with '(1 - 128)' displayed to its right.
- Query Time:** A text input field containing '1', with 'Sec (1 - 10)' displayed to its right.
- Operational Group:** A section with a green header bar containing two rows: 'Maximum' with value '128' and 'Current' with value '0'.
- Apply:** A button at the bottom left of the window.

Interface data are as follows.

Configuration Items	Description
State	Enable or disable MVR
VLAN	VLAN ID to be configured
Mode	<p>Compatible: The CPU of MVR switch normally forwards the query message of router and the join message of client to form the multicast forwarding table of dynamic learning. However, the CPU will not forward the join message to the router port, so the upper router will not receive the following join message, resulting in the router data cannot be forwarded to the switch normally. In this mode, it is necessary to configure the router manually Multicast forwarding table forwards data to switch</p> <p>Dynamic: The only difference between the dynamic mode and the compatible mode is that the CPU can forward the join message to the router port in the dynamic mode, so the upper layer router can learn the multicast forwarding table dynamically, and there is no need to manually configure the multicast forwarding table of the router to forward the data to the switch</p>
Group Start	The starting address of the multicast group
Group Count	Number of multicast group addresses
Query Time	Multicast group query time

2. Fill in corresponding configuration items.

3. “Apply” and finish.

### 11.4.2 Port Setting

Instructions:

1. Click the “Multicast > MVR > Port Setting”, enter the MVR port setting interface as follows:

**Port Setting Table**

<input type="checkbox"/>	Entry	Port	Role	Immediate Leave
<input type="checkbox"/>	1	GE1	None	Disabled
<input type="checkbox"/>	2	GE2	None	Disabled
<input type="checkbox"/>	3	GE3	None	Disabled
<input type="checkbox"/>	4	GE4	None	Disabled
<input type="checkbox"/>	5	GE5	None	Disabled
<input type="checkbox"/>	6	GE6	None	Disabled

**Edit Port Setting**

Port	GE1
Role	<input checked="" type="radio"/> None <input type="radio"/> Receiver <input type="radio"/> Source
Immediate Leave	<input type="checkbox"/> Enable

Interface data are as follows.

Configuration Items	Description
Port	Port list
Role	Port mode Receiver: Represents the port of the switch to which the multicast host is connected, which is used to receive the multicast stream Source: Source port refers to the source port of multicast flow of upper layer equipment, that is, multicast source access port
Immediate Leave	Multicast members leave quickly

### 11.4.3 Group Address

Instructions:

1. Click the “Multicast > MVR > Group Address”, view multicast group information as follows:

**Group Address Table**

Showing  entries      Showing 0 to 0 of 0 entries     

<input type="checkbox"/>	VLAN	Group Address	Member	Type	Life (Sec)
0 results found.					

**Add Group Address**

<b>VLAN</b>	1	
<b>Group Address</b>	<input type="text" value=""/> (0.0.0.0 - 0.0.0.0)	
<b>Member</b>	Available Port	Selected Port
	<input type="text"/>	<input type="text"/>

Interface data are as follows.

Configuration Items	Description
VLAN	VLAN ID for multicast
Group Address	Enter the multicast address
Member	Add multicast member(s)

## 12 Routing

The switch provides three layers of VLAN interface, which is used to communicate

with network layer devices. VLANIF interface is a network layer interface, which can be configured with IP address. Before creating VLANIF interface, the corresponding VLAN should be created first. With the help of VLANIF interface, switches can communicate with other network layer devices.

## 12.1 IPv4 Management and Interfaces

### 12.1.1 IPv4 Interface

Instructions:

1. Click the “Routing > IPv4 Management and Interfaces > IPv4 Interface”, enter IPv4 layer 3 interface configuration as follows:

#### IPv4 Interface Table

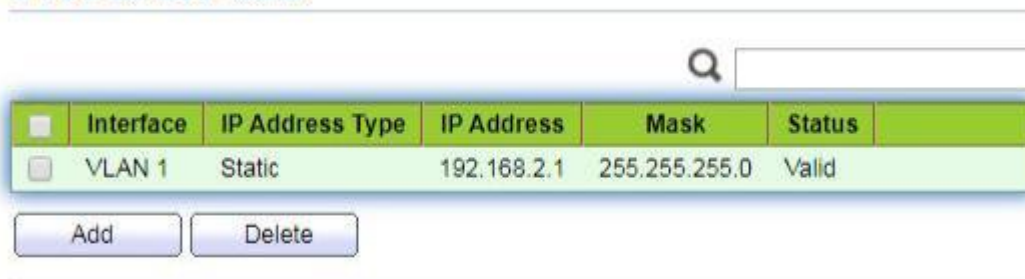

<input type="checkbox"/>	Interface	IP Address Type	IP Address	Mask	Status
<input type="checkbox"/>	VLAN 1	Static	192.168.2.1	255.255.255.0	Valid

#### Add IPv4 Interface

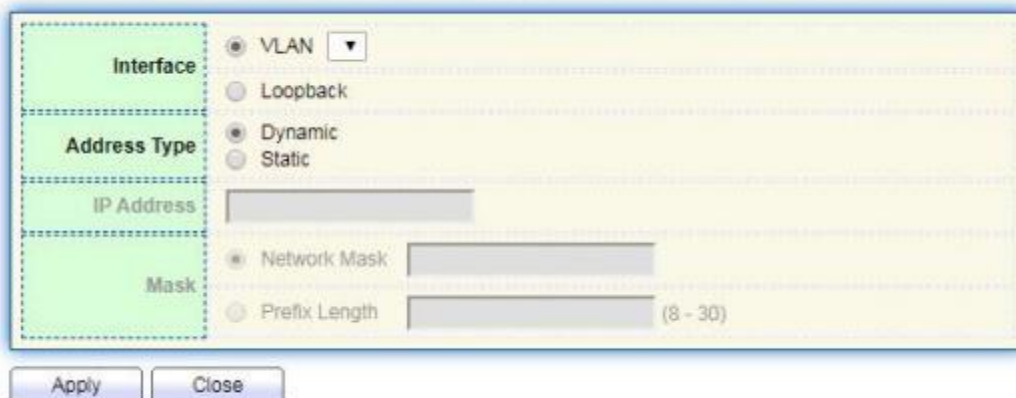

**Interface**
 VLAN 
  
 Loopback

**Address Type**
 Dynamic
   
 Static

**IP Address**

**Mask**
 Network Mask 
  
 Prefix Length  (8 - 30)

Interface data are as follows.

Configuration Items	Description
VLAN	VLAN ID to be configured
Loopback	Loopback interface
Address Type	Dynamic: The IP address of the interface is obtained by DHCP

	Static: The IP address of the interface is configured manually
IP Address	The IP address of the interface
Mask	The IP address mask of the interface

### 12.1.2 IPv4 Routes

Instructions:

1. Click the “Routing > IPv4 Management and Interfaces > IPv4 Routes”, enter IPv4 static route interface configuration as follows:

**IPv4 Routing Table**

Destination IP Prefix	Prefix Length	Route Type	Next Hop Router IP Address	Metric	Administrative Distance	Outgoing Interface
192.168.2.0	24	Directly Connected				MGMT VLAN*

Add Edit Delete

---

**Add IPv4 Static Route**

<b>IP Address</b>	<input type="text"/>
<b>Mask</b>	<input checked="" type="radio"/> Network Mask <input type="text"/> <input type="radio"/> Prefix Length <input type="text"/> (0 - 32)
<b>Next Hop Router IP Address</b>	<input type="text"/>
<b>Metric</b>	<input type="text" value="1"/> (1 - 255, default 1)

Apply Close

Interface data are as follows.

Configuration Items	Description
IP Address	Destination IP address segment
Mask	Destination IP address mask
Next Hop Router IP Address	The next hop IP address needs to be in the same network segment as the interface gateway
Metric	Network hops

### 12.1.3 ARP

Instructions:

1. Click the “Routing > IPv4 Management and Interfaces >ARP”, configure and view ARP table entries as follows:

**ARP Entry Age Out**

---

**Clear ARP Table Entries**

Sec (15 - 21600, default 1200)

All

Dynamic

Static

Normal Age Out

### ARP Table

<input type="checkbox"/>	Interface	IP Address	MAC Address	Status
<input type="checkbox"/>	VLAN 1	192.168.0.20	00:e0:4c:2e:2c:dd	Dynamic
<input type="checkbox"/>	VLAN 1	192.168.1.15	00:e0:4c:2e:2c:dd	Dynamic
<input type="checkbox"/>	VLAN 1	192.168.1.71	04:d4:c4:49:63:fb	Dynamic
<input type="checkbox"/>	VLAN 1	192.168.1.80	b0:6e:bf:c6:dc:1a	Dynamic

### Add ARP

**Interface**

---

**IP Address**

---

**MAC Address**

VLAN 1

Note: Only interfaces with a valid IPv4 address are available for selection

Interface data are as follows.

Configuration Items	Description
Interface	VLANIF interface
IP Address	IP address of the same network segment as the interface gateway
MAC Address	MAC address corresponding to IP address

## 12.2 IPv6 Management and Interfaces

### 12.2.1 IPv6 Interface

Instructions:

1. Click the “Routing > IPv6 Management and Interfaces > IPv6 Interface”, enter IPv6 layer 3 interface configuration as follows:

IPv6 Unicast Routing

 Enable

#### IPv6 Interface Table

Interface	DHCPv6 Client			Auto Configuration	DAD Attempts
	Stateless	Information Refresh Time	Minimum Information Refresh Time		
0 results found.					

#### Add IPv6 Interface

Interface

VLAN

Loopback

Enable

(0 - 600, default 1)

DHCPv6 Client

Stateless

Enable

(86400 - 4294967294, default 86400)

(600 - 4294967294, default 600)

Interface data are as follows.

Configuration Items	Description
VLAN	VLAN ID to be configured
Loopback	Loopback interface
Auto Configuration	Auto configuration switch
DAD Attempts	Configure the number of times neighbor request messages are sent for duplicate address detection

Stateless	Stateless auto configuration
Information Refresh Time	Auto configuration refresh Time
Minimum Information Refresh Time	Minimum refresh time for auto configuration

### 12.2.2 IPv6 Address

Instructions:

1. Click the “Routing > IPv6 Management and Interfaces > IPv6 Address”, enter the IPv6 address configuration interface as follows:

**IPv6 Address Table**

Interface

<input type="checkbox"/>	IPv6 Address Type	IPv6 Address	IPv6 Prefix Length	DAD Status
<input type="checkbox"/>	Link Local	fe80::1e2a:a3ff:fe00:8f	64	Active
<input type="checkbox"/>	Multicast	ff02::1:ff00:8f		
<input type="checkbox"/>	Multicast	ff02::1		
<input type="checkbox"/>	Multicast	ff01::1		

Interface data are as follows.

Configuration Items	Description
Interface	VLANIF interface
IPv6 Address Type	Global: Global IPv6 address Link Local: Local IPv6 address
IPv6 Address	IPv6 address
Prefix Length	Prefix of IPv6 address
EUI-64	Enable or disable the address derived from the IEEE802 address

### 12.2.3 IPv6 Routes

Instructions:

1. Click the “Routing > IPv6 Management and Interfaces > IPv6 Routes”, enter IPv6 static route interface configuration as follows:

**IPv6 Routing Table**

Q

Destination IP Prefix	Prefix Length	Route Type	Next Hop Router IP Address	Metric	Administrative Distance	Outgoing Interface
0 results found.						

Add Edit Delete

---

**Add IPv6 Static Route**

<b>IPv6 Prefix</b>		
<b>IPv6 Prefix Length</b>		(0 - 128)
<b>Next Hop Router IP Address</b>		
<b>Metric</b>	1	(1 - 255, default 1)

Apply Close

Interface data are as follows.

Configuration Items	Description
IPv6 Prefix	Destination IPv6 address segment
IPv6 Prefix Length	Destination IPv6 address prefix
Next Hop Router IP Address	The next hop IPv6 address needs to be in the same network segment as the interface gateway
Metric	Network hops

## 12.2.4 Neighbors

Instructions:

1. Click the “Routing > IPv6 Management and Interfaces > Neighbors”, configure and view IPv6 neighbor table entries as follows:

Clear Neighbor Table

All  
 Dynamic  
 Static  
 N/A

### IPv6 Neighbor Table

<input type="checkbox"/>	Interface	IPv6 Address	MAC Address	Status	Router
0 results found.					

### Add Neighbor

Interface

VLAN

IP Address

MAC Address

Interface data are as follows.

Configuration Items	Description
Interface	VLANIF interface
IP Address	IPv6 address of the same network segment as the interface gateway
MAC Address	MAC address corresponding to IPv6 address

## 12.3 Rip Routes Management

The routing information protocol (RIP) is a relatively outdated but still widely used internal gateway protocol (IGP), which is mainly used in the smaller homogeneous networks. RIP is a classical distance vector routing protocol, which appears in RFC 1058, and presents an improved RIP-2 among RFC1388, and was revised in RFC 1723 and RFC 2453.

RIP uses Bellman-For algorithm currently RIP IPv4 has two versions, RIPv1 and RIPv2. RIP has the following main features:

RIP is a typical distance vector routing protocol.

RIP messages sent by the broadcast address 255.255.255.255, RIPv2 send messages by using multicast address 224.0.0.9, both using the port 520 of UDP

RIP takes the minimum hop count to the destination network as the routing metric, rather than the bandwidth and delay of the link.

RIP is designed for small networks. The number of hops is limited to 15 hops, and the 16 hop is not reachable.

RIP-1 is a kind of class routing protocol, does not supporting discontinuous subnet design.

RIP-2 support CIDR and VLSM variable subnet mask, which make it supports the discontinuous subnet mask design

RIP periodic full routing updating, make the routing table broadcast to the neighbor router, broadcast cycle default 30 seconds.

RIP protocol management distance is 120.

For small networks, in terms of occupied bandwidth, RIP is small cost and easy to configure, manage, and implement, and RIP is still in use. But RIP also has obvious shortcomings. When there is more than one network will appear loop problem. In order to solve the loop problem, IETF proposed a split-Horizon method, the routing information received at this interface will no longer go out from the interface. The scope of the division solves the routing loop problem between two routers, but can't prevent the problem which is the loop mainly formed by delay factor because of large scale network. The trigger update requires the router to transmit its routing table immediately when the link changes. These speeds up the convergence of the network, but prone to broadcast flooding. In short, the solution of the loop problem needs to consume a certain amount of time and bandwidth. If the RIP protocol is adopted, the number of links in the network can't exceed 15, which makes the RIP protocol is not suitable for large networks.

## **RIP Working principle**

RIP is a distributed type routing protocol based on distance vector, which is the standard protocol of the Internet. Its biggest advantage is simple. The RIP protocol requires that each router in the network maintain a distance record from itself to each other destination network. The RIP protocol defines "distance" as: the distance of a router directly connected network defines as 1. the distance of a router not directly connected network defines as pass each router plus 1. "Distance" is also called "hops". RIP allows one path contain up to 15 routers, so distance equal to 16 is unreachable. So RIP protocol only applies to small Internet.

RIP 2 comes from RIP and is a supplementary protocol for RIP. It is mainly used to increase the number of loaded useful information and increase its security performance. RIPv1 and RIPv2 are UDP-based protocols. Under RIP2, each host or router sends and

receives packets from UDP port 520 through the routing select process. The default routing update period for RIP protocol is 30S.

Instructions

1. Click on the “Routing > Rip Routes Management > Rip Routes Setting” in the navigation tree as follows.

**Rip Routes Info**

Rip Routes status  Enable

Apply

2. Network Setting table, click “Add” enter the configuration interface as follows.

**Network Setting table**

Showing All entries Showing 0 to 0 of 0 entries

Network Ipv4 Address	Network Mask
0 results found.	

Add Delete First Previous 1 Next Last

**Network Setting table**

Network Ipv4 Address

Network Mask

Apply Close

---

**Notice:**

Before configuring and publishing the network, please configure the interface IP and ensure that the IP protocol and physical state of the interface are up

---

## 12.4 Ospf Routes Management

OSPF (Open Shortest Path First) is an Interior Gateway Protocol (IGP) for routing decisions within a single autonomous system (AS). It is an implementation of the link state routing protocol, under the internal gateway protocol (IGP). It is operating within the autonomous system. The shortest path is calculated using the Dijkstra algorithm.

OSPF is IGP routing protocols developed by IETF's OSPF workgroup OSPF designed

for IP networks support IP subnet and external routing information marking, also allows authentication of message and supports IP multicast

OSPF routing protocol is a typical link state routing protocol, which is generally used in the same routing domain. Here, routing domain refers to an autonomous system (as), which refers to a group of networks that exchange routing information through a unified routing policy or routing protocol. In this as, all OSPF routers maintain the same database describing the as structure, which stores the state information of the corresponding links in the routing domain. It is through this database that OSPF routers calculate their OSPF routing tables

As a link state routing protocol, OSPF transmits link state multicast data LSA (link state advertisement) to all routers in a certain area, which is different from distance vector routing protocol. The router running distance vector routing protocol passes part or all of the routing tables to its neighboring routers

As for the security of information exchange, OSPF stipulates that any information exchange between routers can be authenticated when necessary, so as to ensure that only trusted routers can transmit routing information. OSPF supports a variety of authentication mechanisms, and allows different authentication mechanisms to be used among different regions. OSPF optimizes the application of link state algorithm in broadcast network (such as Ethernet) in order to make full use of hardware broadcast ability to transmit link state messages. Usually, in the topology of link state algorithm, a node represents a router. If all k routers are connected to the Ethernet, when the link state is broadcast, the packets about these K routers will reach the square of K. Therefore, OSPF allows a node to represent a broadcast network in the topology diagram. All routers in each broadcast network send link status messages to report the link status of routers in the network

Instructions

1. Click on the “Routing > Ospf Routes Management > Ospf Routes Setting” in the navigation tree as follows.



2. Area Network Setting, click “Add” enter the configuration interface as follows.

## Area Network Setting table

Showing  entries      Showing 0 to 0 of 0 entries     

Area Id	Network Ipv4 Address	Network Mask
0 results found.		

## Area Network Setting table

Area Id	<input type="text" value="A.B.C.D"/>
Network Ipv4 Address	<input type="text"/>
Network Mask	<input type="text"/>

---

### Notice:

Before configuring and publishing the network, please configure the interface IP and ensure that the IP protocol and physical state of the interface are up

---

## 13 Security

### 13.1 RADIUS

Instructions:

1. Click the "Security > RADIUS", enter RADIUS interface as follows:

**Use Default Parameter**

<b>Retry</b>	<input type="text" value="3"/>	(1 - 10, default 3)
<b>Timeout</b>	<input type="text" value="3"/>	Sec (1 - 30, default 3)
<b>Key String</b>	<input type="text"/>	

### RADIUS Table

Showing All entries      Showing 0 to 0 of 0 entries     

<input type="checkbox"/>	Server Address	Server Port	Priority	Retry	Timeout	Usage
0 results found.						

### Add RADIUS Server

<b>Address Type</b>	<input checked="" type="radio"/> Hostname <input type="radio"/> IPv4 <input type="radio"/> IPv6
<b>Server Address</b>	<input type="text"/>
<b>Server Port</b>	<input type="text" value="1812"/> (0 - 65535, default 1812)
<b>Priority</b>	<input type="text"/> (0 - 65535)
<b>Key String</b>	<input checked="" type="checkbox"/> Use Default <input type="text"/>
<b>Retry</b>	<input checked="" type="checkbox"/> Use Default <input type="text" value="3"/> (1 - 10, default 3)
<b>Timeout</b>	<input checked="" type="checkbox"/> Use Default <input type="text" value="3"/> Sec (1 - 30, default 3)
<b>Usage</b>	<input type="radio"/> Login <input type="radio"/> 802.1X <input checked="" type="radio"/> All

Interface data are as follows.

Configuration Items	Description
Address Type	Depending on the type, you can choose Hostname, IPv4, IPv6
Server Address	Server's IP address
Server Port	Service's port

Priority	Service's priority
Key String	The secret key, shared between the RADIUS server and the switch
Retry	Retransmit is the number of times
Timeout	to wait for a reply from a RADIUS server before retransmitting the request
Usage	Usage scenarios

## 13.2 TACACS+

Instructions:

1. Click the "Security > TACACS+", enter TACACS+ interface as follows:

**Use Default Parameter**

**Timeout**

Sec (1 - 30, default 5)

**Key String**

### TACACS+ Table

Showing All entries      Showing 0 to 0 of 0 entries     

	Server Address	Server Port	Priority	Timeout
0 results found.				

### Add TACACS+ Server

<b>Address Type</b>	<input checked="" type="radio"/> Hostname <input type="radio"/> IPv4 <input type="radio"/> IPv6
<b>Server Address</b>	<input type="text"/>
<b>Server Port</b>	<input type="text" value="49"/> (0 - 65535, default 49)
<b>Priority</b>	<input type="text"/> (0 - 65535)
<b>Key String</b>	<input checked="" type="checkbox"/> Use Default <input type="text"/>
<b>Timeout</b>	<input checked="" type="checkbox"/> Use Default <input type="text" value="5"/> Sec (1 - 30, default 5)

Interface data are as follows.

Configuration Items	Description
Address Type	Depending on the type, you can choose Hostname, IPv4, IPv6
Server Address	Server's IP address
Server Port	Service's port
Priority	Service's priority
Key String	The secret key, shared between the RADIUS server and the switch
Retry	Retransmit is the number of times
Timeout	to wait for a reply from a RADIUS server before retransmitting the request

## 13.3 AAA

### 13.3.1 Method List

Instructions:

1. Click the "Security > AAA > Method List", enter method list interface as follows:

## Method List Table

Showing  entries

Showing 1 to 1 of 1 entries



<input type="checkbox"/>	Name	Sequence
<input type="checkbox"/>	default	(1) Local

### Add Method List

<b>Name</b>	<input type="text"/>
<b>Method 1</b>	<input checked="" type="radio"/> Empty <input type="radio"/> None <input type="radio"/> Local <input type="radio"/> Enable <input type="radio"/> RADIUS <input type="radio"/> TACACS+
<b>Method 2</b>	<input checked="" type="radio"/> Empty <input type="radio"/> None <input type="radio"/> Local <input type="radio"/> Enable <input type="radio"/> RADIUS <input type="radio"/> TACACS+
<b>Method 3</b>	<input checked="" type="radio"/> Empty <input type="radio"/> None <input type="radio"/> Local <input type="radio"/> Enable <input type="radio"/> RADIUS <input type="radio"/> TACACS+
<b>Method 4</b>	<input checked="" type="radio"/> Empty <input type="radio"/> None <input type="radio"/> Local <input type="radio"/> Enable <input type="radio"/> RADIUS <input type="radio"/> TACACS+

Interface data are as follows.

Configuration Items	Description
Name	Method name
Method 1-4	Empty: Method is disable None: Do nothing and just make user to be authenticated Local: Use local user account database to authenticate Enable: Use local enable password database to authenticate RADIUS: Use remote Radius server to authenticate TACACS+: Use remote TACACS+ server to authenticate

### 13.3.2 Login Authentication

Instructions:

1. Click the “Security > AAA > Login Authentication”, enter login authentication interface as follows:

Console	default ▼	(1) Local
Telnet	default ▼	(1) Local
SSH	default ▼	(1) Local
HTTP	default ▼	(1) Local
HTTPS	default ▼	(1) Local

Apply

## 13.4 Management Access

### 13.4.1 Management Service

Instructions for Telnet:

1. Click the “Security > Management Access > Management Service”, enter management service interface as follows:

Management Service	
Telnet	<input checked="" type="checkbox"/> Enable
SSH	<input type="checkbox"/> Enable
HTTP	<input checked="" type="checkbox"/> Enable
HTTPS	<input type="checkbox"/> Enable
SNMP	<input type="checkbox"/> Enable

Session Timeout	
Console	10 Min (0 - 65535, default 10)
Telnet	10 Min (0 - 65535, default 10)
SSH	10 Min (0 - 65535, default 10)
HTTP	10 Min (0 - 65535, default 10)
HTTPS	10 Min (0 - 65535, default 10)

Instructions for SSH:

2. Click the “Security > Management Access > Management Service”, enter

management service interface as follows:

Management Service		
Telnet	<input type="checkbox"/>	Enable
SSH	<input checked="" type="checkbox"/>	Enable
HTTP	<input checked="" type="checkbox"/>	Enable
HTTPS	<input type="checkbox"/>	Enable
SNMP	<input type="checkbox"/>	Enable

Session Timeout		
Console	<input type="text" value="10"/>	Min (0 - 65535, default 10)
Telnet	<input type="text" value="10"/>	Min (0 - 65535, default 10)
SSH	<input type="text" value="10"/>	Min (0 - 65535, default 10)

Instructions for HTTPS:

3. Click the "Security > Management Access > Management Service", enter management service interface as follows:

Management Service		
Telnet	<input type="checkbox"/>	Enable
SSH	<input type="checkbox"/>	Enable
HTTP	<input checked="" type="checkbox"/>	Enable
HTTPS	<input checked="" type="checkbox"/>	Enable
SNMP	<input type="checkbox"/>	Enable

Session Timeout		
Console	<input type="text" value="10"/>	Min (0 - 65535, default 10)
Telnet	<input type="text" value="10"/>	Min (0 - 65535, default 10)
SSH	<input type="text" value="10"/>	Min (0 - 65535, default 10)
HTTP	<input type="text" value="10"/>	Min (0 - 65535, default 10)
HTTPS	<input type="text" value="10"/>	Min (0 - 65535, default 10)

Instructions for SNMP:

4. Click the "Security > Management Access > Management Service", enter management service interface as follows:

Management Service	
Telnet	<input type="checkbox"/> Enable
SSH	<input type="checkbox"/> Enable
HTTP	<input checked="" type="checkbox"/> Enable
HTTPS	<input type="checkbox"/> Enable
SNMP	<input checked="" type="checkbox"/> Enable

### 13.4.2 Management ACL

ACLs applied to management

Instructions:

1. Click the "Security > Management Access > Management ACL", enter management ACL interface as follows:

ACL Name

---

#### Management ACL Table

Showing All entries      Showing 0 to 0 of 0 entries     

<input type="checkbox"/>	ACL Name	State	Rule
0 results found.			

2. Click the "Security > Management Access > Management ACE", enter management ACE interface as follows:

ACL Name None

Showing All entries      Showing 0 to 0 of 0 entries     

<input type="checkbox"/>	Priority	Action	Service	Port	Address / Mask
0 results found.					

Add Management ACE

ACL Name	a	
Priority	1	(1 - 65535)
Service	<input type="radio"/> All <input type="radio"/> Http <input type="radio"/> Https <input checked="" type="radio"/> Snmp <input type="radio"/> SSH <input type="radio"/> Telnet	
Action	<input type="radio"/> Permit <input checked="" type="radio"/> Deny	
Port	Available Port GE1 GE2 GE3 GE4 GE5 GE6 GE7 GE8	Selected Port  
IP Version	<input checked="" type="radio"/> All <input type="radio"/> IPv4 <input type="radio"/> IPv6	
IPv4	/ 255.255.255.255	
IPv6	/ 128 (1 - 128)	

Apply Close

Interface data are as follows.

Configuration Items	Description
ACL Name	ACL name
Priority	ACL Priority
Service	Type of service used
Action	Match action
Port	The port on which this ACL is applied
IP Version	Manage the version of the IP address
IPv4	IPv4 address
IPv6	IPv6 address

# 13.5 Authentication Manager

## 13.5.1 Property

Enable the global setting of 802.1x/MAC/WEB authentication network access control

Instructions:

1. Click the “Security > Management Manager > Property”, enter global interface as follows:

Port Mode Table

Entry	Port	Authentication Type			Host Mode	Order	Method	Guest VLAN	VLAN Assign Mode	
		802.1x	MAC-Based	WEB-Based						
<input type="checkbox"/>	1	GE1	Enabled	Disabled	Disabled	Multiple Authentication	802.1x	RADIUS	Disabled	Static
<input type="checkbox"/>	2	GE2	Disabled	Disabled	Disabled	Multiple Authentication	802.1x	RADIUS	Disabled	Static
<input type="checkbox"/>	3	GE3	Disabled	Disabled	Disabled	Multiple Authentication	802.1x	RADIUS	Disabled	Static
<input type="checkbox"/>	4	GE4	Disabled	Disabled	Disabled	Multiple Authentication	802.1x	RADIUS	Disabled	Static
<input type="checkbox"/>	5	GE5	Disabled	Disabled	Disabled	Multiple Authentication	802.1x	RADIUS	Disabled	Static
<input type="checkbox"/>	6	GE6	Disabled	Disabled	Disabled	Multiple Authentication	802.1x	RADIUS	Disabled	Static
<input type="checkbox"/>	7	GE7	Disabled	Disabled	Disabled	Multiple Authentication	802.1x	RADIUS	Disabled	Static

### Edit Port Mode

<b>Port</b>	GE1				
<b>Authentication Type</b>	<input type="checkbox"/> 802.1x <input type="checkbox"/> MAC-Based <input type="checkbox"/> WEB-Based				
<b>Host Mode</b>	<input checked="" type="radio"/> Multiple Authentication <input type="radio"/> Multiple Hosts <input type="radio"/> Single Host				
<b>Order</b>	<table border="0"> <tr> <td>Available Type</td> <td>Select Type</td> </tr> <tr> <td>MAC-Based WEB-Based</td> <td>802.1x</td> </tr> </table>	Available Type	Select Type	MAC-Based WEB-Based	802.1x
Available Type	Select Type				
MAC-Based WEB-Based	802.1x				
<b>Method</b>	<table border="0"> <tr> <td>Available Method</td> <td>Select Method</td> </tr> <tr> <td>Local</td> <td>RADIUS</td> </tr> </table>	Available Method	Select Method	Local	RADIUS
Available Method	Select Method				
Local	RADIUS				
<b>Guest VLAN</b>	<input type="checkbox"/> Enable				
<b>VLAN Assign Mode</b>	<input type="radio"/> Disable <input type="radio"/> Reject <input checked="" type="radio"/> Static				

Apply Close

Interface data are as follows.

Configuration Items	Description
Port	Port list
Authentication Type	Port authentication type
Host Mode	<p>Multiple Authentication: In this mode, every client needs to pass authenticate procedure individually.</p> <p>Multiple Hosts: In this mode, only one client need to be authenticated and other clients will get the same access accessibility.</p> <p>Single Host: In this mode, only one host can be authenticated. It is the same as multi-auth mode with max hosts number configure to be 1</p>
Order	Match action
Method	Port authentication method order
Guest VLAN	Guest VLAN

VLAN Assign Mode	<p>Port RADIUS VLAN assign mode</p> <p>Reject: If get VLAN authorized information, just use it. However, if there is no VLAN authorized information, reject the host and make it unauthorized</p> <p>Static: If get VLAN authorized information, just use it. If there is no VLAN authorized information, keep original VLAN of host.</p>
------------------	---

### 13.5.2 Port Setting

Instructions:

1. Click the “Security > Management Manager > Port Setting”, enter port setting interface as follows:

Port Setting Table

#	Entry	Port	Port Control	Reauthentication	Max Hosts	Common Timer				RADIUS Parameters			Web-Based Parameters	
						Reauthentication	Inactive	Guest	TX Period	Supplicant Timeout	Server Timeout	Max Request	Max Login	
<input type="checkbox"/>	1	GE1	Disabled	Disabled	256	3600	60	60	30	30	30	2	3	
<input type="checkbox"/>	2	GE2	Disabled	Disabled	256	3600	60	60	30	30	30	2	3	
<input type="checkbox"/>	3	GE3	Disabled	Disabled	256	3600	60	60	30	30	30	2	3	
<input type="checkbox"/>	4	GE4	Disabled	Disabled	256	3600	60	60	30	30	30	2	3	
<input type="checkbox"/>	5	GE5	Disabled	Disabled	256	3600	60	60	30	30	30	2	3	
<input type="checkbox"/>	6	GE6	Disabled	Disabled	256	3600	60	60	30	30	30	2	3	
<input type="checkbox"/>	7	GE7	Disabled	Disabled	256	3600	60	60	30	30	30	2	3	
<input type="checkbox"/>	8	GE8	Disabled	Disabled	256	3600	60	60	30	30	30	2	3	

### Edit Port Setting

<b>Port</b>	GE1-GE2	
<b>Port Control</b>	<input checked="" type="radio"/> Disabled <input type="radio"/> Force Authorized <input type="radio"/> Force Unauthorized <input type="radio"/> Auto	
<b>Reauthentication</b>	<input type="checkbox"/> Enable	
<b>Max Hosts</b>	<input type="text" value="256"/>	(1 - 256, default 256)
<b>Common Timer</b>		
<b>Reauthentication</b>	<input type="text" value="3600"/>	Sec (300 - 2147483647, default 3600)
<b>Inactive</b>	<input type="text" value="60"/>	Sec (60 - 65535, default 60)
<b>Quiet</b>	<input type="text" value="60"/>	Sec (0 - 65535, default 60)
<b>802.1x Parameters</b>		
<b>TX Period</b>	<input type="text" value="30"/>	Sec (1 - 65535, default 30)
<b>Supplicant Timeout</b>	<input type="text" value="30"/>	Sec (1 - 65535, default 30)
<b>Server Timeout</b>	<input type="text" value="30"/>	Sec (1 - 65535, default 30)
<b>Max Request</b>	<input type="text" value="2"/>	(1 - 10, default 2)
<b>Web-Based Parameters</b>		
<b>Max Login</b>	<input type="checkbox"/> Infinite	
	<input type="text" value="3"/>	(3 - 10, default 3)

Interface data are as follows.

Configuration Items	Description
Port	Port list
Port Control	Force Authorized: Port is force authorized and all clients have network accessibility. Force Unauthorized: Port is force unauthorized and all clients Auto: Need passing authentication procedure to get network accessibility
Reauthentication	Enable the port reauthentication
Max Hosts	The port max hosts number for multi-auth mode
Reauthentication	The port reauthentication period value with unit second if the reauthentication time is not assigned by local database or remote authentication server
Inactive	The port inactive timeout value
Quiet	the port quiet period value

TX Period	The port 802.1x EAP TX period value
Supplicant Timeout	The port supplicant timeout value
Server Timeout	The port 802.1x server timeout value
Max Request	The port 802.1x max EAP request value
Max Login	The port WEB authentication max login attempt number

### 13.5.3 MAC-Based Local Account

Instructions:

1. Click the “Security > Management Manager > MAC-Based Local Account”, enter configuration interface as follows:

#### MAC-Based Local Account Table

Showing All entries      Showing 0 to 0 of 0 entries     

MAC Address	Control	VLAN	Timeout (Sec)	
			Reauthentication	Inactive
0 results found.				

### 13.5.4 WEB-Based Local Account

Instructions:

1. Click the “Security > Management Manager > WEB-Based Local Account”, enter configuration interface as follows:

#### WEB-Based Local Account Table

Showing All entries      Showing 0 to 0 of 0 entries     

Username	VLAN	Timeout (Sec)	
		Reauthentication	Inactive
0 results found.			

## 13.5.5 Sessions

Instructions:

1. Click the “Security > Management Manager > Sessions”, view sessions interface as follows:



The screenshot shows a web interface titled "Sessions Table". At the top, it says "Showing All entries" and "Showing 0 to 0 of 0 entries". There is a search bar on the right. Below this is a table with the following columns: Session ID, Port, MAC Address, Current Type, Status, Operational Information (sub-columns: VLAN, Session Time, Inactivated Time, Quiet Time), and Authorized Information (sub-columns: VLAN, Reauthentication Period, Inactive Timeout). The table is currently empty, with the text "0 results found." centered below the column headers. At the bottom of the table, there are navigation buttons: "Clear", "Refresh", "First", "Previous", "1", "Next", and "Last".

	Session ID	Port	MAC Address	Current Type	Status	Operational Information				Authorized Information		
						VLAN	Session Time	Inactivated Time	Quiet Time	VLAN	Reauthentication Period	Inactive Timeout
0 results found.												

## 13.6 DoS

### 13.6.1 Property

Enable the Attack Resistance option to make the switch more secure.

Instructions

1. Click the “Security > DoS > Property” to the “DoS Global Configuration” interface as follows.

POD	<input checked="" type="checkbox"/>	Enable
Land	<input checked="" type="checkbox"/>	Enable
UDP Blat	<input checked="" type="checkbox"/>	Enable
TCP Blat	<input checked="" type="checkbox"/>	Enable
DMAC = SMAC	<input checked="" type="checkbox"/>	Enable
Null Scan Attack	<input checked="" type="checkbox"/>	Enable
X-Mas Scan Attack	<input checked="" type="checkbox"/>	Enable
TCP SYN-FIN Attack	<input checked="" type="checkbox"/>	Enable
TCP SYN-RST Attack	<input checked="" type="checkbox"/>	Enable
ICMP Fragment	<input checked="" type="checkbox"/>	Enable
TCP-SYN	<input checked="" type="checkbox"/>	Enable Note: Source Port < 1024
TCP Fragment	<input checked="" type="checkbox"/>	Enable Note: Offset = 1
Ping Max Size	<input checked="" type="checkbox"/>	Enable IPv4
	<input checked="" type="checkbox"/>	Enable IPv6
	<input type="text" value="512"/>	Byte (0 - 65535, default 512)
TCP Min Hdr size	<input checked="" type="checkbox"/>	Enable
	<input type="text" value="20"/>	Byte (0 - 31, default 20)
IPv6 Min Fragment	<input checked="" type="checkbox"/>	Enable
	<input type="text" value="1240"/>	Byte (0 - 65535, default 1240)
Smurf Attack	<input checked="" type="checkbox"/>	Enable
	<input type="text" value="0"/>	Netmask Length (0 - 32, default 0)

Apply

### 13.6.2 Port Setting

DoS attack resistance is enabled based on ports.

Instructions

1. Click the "Security > DoS > Port Setting" as follows:

Port Setting Table

<input type="checkbox"/>	Entry	Port	State
<input type="checkbox"/>	1	GE1	Disabled
<input type="checkbox"/>	2	GE2	Disabled
<input type="checkbox"/>	3	GE3	Disabled
<input type="checkbox"/>	4	GE4	Disabled

2. Select and “Edit” the port to enable or disable the DoS attack resistance function as follows.

**Edit Port Setting**

Port	GE1
State	<input checked="" type="checkbox"/> Enable

Apply Close

## 13.7 Dynamic ARP Inspection

### 13.7.1 Property

Instructions

1. Click the “Security > Dynamic ARP Inspection > Property” enter global configuration interface as follows:

**State**  Enable

**VLAN**

Available VLAN	Selected VLAN
VLAN 1 VLAN 5	

Apply

2. Select the port and “Edit” to enter the port configuration interface as follows:

**Port Setting Table**

Entry	Port	Trust	Source MAC Address	Destination MAC Address	IP Address	Rate Limit
<input type="checkbox"/> 1	GE1	Disabled	Disabled	Disabled	Disabled	Unlimited
<input type="checkbox"/> 2	GE2	Disabled	Disabled	Disabled	Disabled	Unlimited
<input type="checkbox"/> 3	GE3	Disabled	Disabled	Disabled	Disabled	Unlimited
<input type="checkbox"/> 4	GE4	Disabled	Disabled	Disabled	Disabled	Unlimited
<input type="checkbox"/> 5	GE5	Disabled	Disabled	Disabled	Disabled	Unlimited
<input type="checkbox"/> 6	GE6	Disabled	Disabled	Disabled	Disabled	Unlimited

## Edit Port Setting

Port	GE1-GE2
Trust	<input type="checkbox"/> Enable
Source MAC Address	<input type="checkbox"/> Enable
Destination MAC Address	<input type="checkbox"/> Enable
IP Address	<input type="checkbox"/> Enable <input type="checkbox"/> Allow Zero (0.0.0.0)
Rate Limit	<input type="text" value="0"/> pps (1 - 50, default 0), 0 is Unlimited

## 13.7.2 Statistics

Instructions

1. Click the “Security > Dynamic ARP Inspection > Statistics” view DAI statistics as follows:

### Statistics Table

Entry	Port	Forward	Source MAC Failure	Destination MAC Failure	Source IP Validation Failure	Destination IP Validation Failure	IP-MAC Mismatch Failure
<input type="checkbox"/>	1 GE1	0	0	0	0	0	0
<input type="checkbox"/>	2 GE2	0	0	0	0	0	0
<input type="checkbox"/>	3 GE3	0	0	0	0	0	0
<input type="checkbox"/>	4 GE4	0	0	0	0	0	0
<input type="checkbox"/>	5 GE5	0	0	0	0	0	0
<input type="checkbox"/>	6 GE6	0	0	0	0	0	0
<input type="checkbox"/>	7 GE7	0	0	0	0	0	0
<input type="checkbox"/>	8 GE8	0	0	0	0	0	0

## 13.8 DHCP Snooping

For sake of security, the network administrator may need to record the IP address of a user surfing the Internet and to confirm the correspondence between the IP address obtained from DHCP Server and the host’s MAC address.

Switch can record the user’s IP address through the secure DHCP relay at the network layer.

Switch can monitor DHCP messages and record the user’s IP address through DHCP Snooping at the data link layer. In addition, private DHCP Server in the network may lead to wrong IP address for the user. To ensure that users obtain IP addresses through legal DHCP Server, the DHCP Snooping security mechanism divides the ports into Trust Port

and Untrust Port.

Trust Port directly or indirectly connects legal DHCP Server. It forwards the DHCP messages received to ensure the correct IP address for DHCP Client. Untrust Port connects illegal DHCP Server. DHCPACK and DHCPOFFER messages received from the DHCP Server on the Untrust Port will be discarded to prevent incorrect IP addresses.

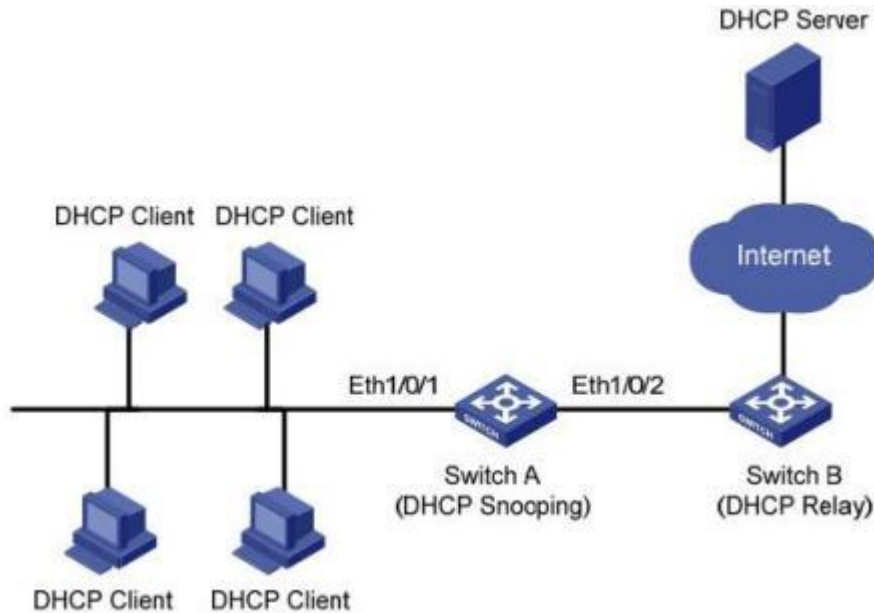

Typical Networking of DHCP Snooping

The following methods are used to obtain the IP address and user MAC address from DHCP Server:

- Snooping the DHCPREQUEST message
- Snooping the DHCPACK message

### 13.8.1 Property

Enable DHCP Snooping

Instructions:

1. Click the "Security > DHCP Snooping > Property". DHCP Snooping interface is divided into global configuration and port configuration. Select the port to be modified in the port configuration and "Edit" the details as follows:

**State**  Enable

**VLAN**

Available VLAN: VLAN 1, VLAN 10, VLAN 100

Selected VLAN:

Apply

### Port Setting Table

Q

<input type="checkbox"/>	Entry	Port	Trust	Verify Chaddr	Rate Limit
<input type="checkbox"/>	1	GE1	Disabled	Disabled	Unlimited
<input type="checkbox"/>	2	GE2	Disabled	Disabled	Unlimited
<input type="checkbox"/>	3	GE3	Disabled	Disabled	Unlimited
<input type="checkbox"/>	4	GE4	Disabled	Disabled	Unlimited
<input type="checkbox"/>	5	GE5	Disabled	Disabled	Unlimited
<input type="checkbox"/>	6	GE6	Disabled	Disabled	Unlimited
<input type="checkbox"/>	7	GE7	Disabled	Disabled	Unlimited
<input type="checkbox"/>	8	GE8	Disabled	Disabled	Unlimited

### Edit Port Setting

**Port** GE1-GE2

**Trust**  Enable

**Verify Chaddr**  Enable

**Rate Limit**  pps (1 - 300, default 0), 0 is Unlimited

Apply Close

Interface data are as follows.

Configuration Items	Description
State	Enable and disable the DHCP Snooping
VLAN	Valid VLAN No. of DHCP Snooping
Port	Configure the port No. of DHCP Snooping
Trust	Whether the port is a Trust Port

Client Inspection	Address	Whether the consistency inspection for Client addresses is enabled
Rate Limit		Whether the port enables rate limit and configures the value

- Fill in corresponding configuration items.
- “Apply” and finish as follows.

#### Port Setting Table

<input type="checkbox"/>	Entry	Port	Trust	Verify Chaddr	Rate Limit
<input type="checkbox"/>	1	GE1	Enabled	Enabled	100
<input type="checkbox"/>	2	GE2	Enabled	Enabled	100
<input type="checkbox"/>	3	GE3	Disabled	Disabled	Unlimited
<input type="checkbox"/>	4	GE4	Disabled	Disabled	Unlimited

### 13.8.2 Statistics

Instructions

- Click the “Security > Dynamic ARP Inspection > Statistics” view DHCP Snooping statistics as follows:

#### Statistics Table

<input type="checkbox"/>	Entry	Port	Forward	Chaddr Check Drop	Untrust Port Drop	Untrust Port with Option82 Drop	Invalid Drop
<input type="checkbox"/>	1	GE1	0	0	0	0	0
<input type="checkbox"/>	2	GE2	0	0	0	0	0
<input type="checkbox"/>	3	GE3	0	0	0	0	0
<input type="checkbox"/>	4	GE4	0	0	0	0	0
<input type="checkbox"/>	5	GE5	0	0	0	0	0
<input type="checkbox"/>	6	GE6	0	0	0	0	0
<input type="checkbox"/>	7	GE7	0	0	0	0	0

### 13.8.3 Option82 Property

Private DHCP Servers in the network may lead to wrong IP addresses obtained by

users. DHCP Snooping security mechanism based on PS7024 Ethernet switch divides the ports into Trust Port and Untrust Port in order to provide the IP addresses through legal DHCP Servers.

- Trust Port directly or indirectly connects legal DHCP Server. It ensures the correct IP address for DHCP Client by forwarding the DHCP messages received.
- Untrust Port connects illegal DHCP servers. DHCP ACK and DHCP OFFER messages responded by DHCP Server on untrusted ports will be discarded to prevent incorrect IP addresses.

Option 82 is the Relay Agent Information Option in DHCP messages, which records the location of DHCP Client. When the DHCP relay (or DHCP Snooping device) receives the request, message sent from DHCP Client to DHCP Server, administrators can add the Option 82 to locate the DHCP Client and control the security, cost, etc. More flexible approaches to address allocation are created by the servers supporting Option 82 in line with the IP addresses and other parameters allocation policies.

Up to 255 sub-options are contained in the Option 82. At least one sub-option should be defined if Option 82 is defined. The current device supports 2 sub-options: Circuit ID Sub-option and Remote ID Sub-option

Manufacturers usually fill options as needed since RFC 3046 fails to uniform the Option 82 options. As the DHCP relay device, Ethernet switch supports the extended padding formats for Option 82 sub-options and the padding defaults are as follows:

- Sub-option 1: VLAN No. and port index (port physical number minus 1) of the port receiving the Request message sent by DHCP Client.
- Sub-option 2: bridge MAC address of DHCP relay device receiving the DHCP Client Request message.

Sub-option 1: VLAN No. and port index (port physical number minus 1) of the port receiving the Request message sent by DHCP Client as follows.

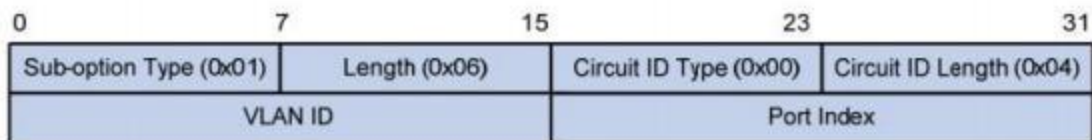

Sub-option 2: bridge MAC address of DHCP relay device receiving the DHCPREQUEST message of DHCP Client.

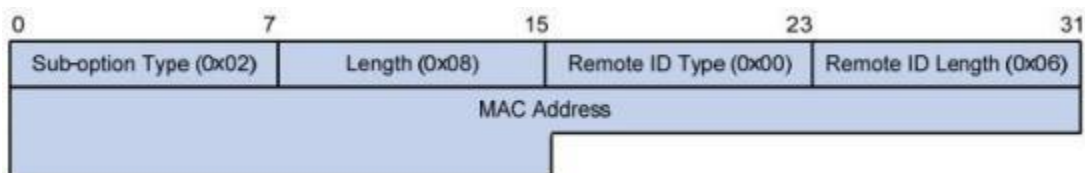

### DHCP Relay Supporting Mechanism of Option 82

The processes of DHCP Client acquiring IP address from DHCP Server through DHCP relay is basically the same as that directly from DHCP Server. Steps of discovery, provision, selection, and validation are essential. The supporting mechanism of DHCP

relay is introduced as follows:

(1) DHCP relay will check the Option 82 in the DHCPREQUEST message received and handle it accordingly.

- For existing Option 82 messages, DHCP relay will process according to the configuration policies (discarding, replacing with relay Option 82, or maintaining original Option 82), and then forward to DHCP Server.
- For messages without Option 82, DHCP relay will add and forward the new messages to DHCP Server.

(2) DHCP relay will peel off Option 82 from the response message received from DHCP Server, and then forward the message with DHCP configuration info to DHCP Client.

#### Description:

DHCP Client transmits a DHCPDISCOVERY message and a DHCPREQUEST message. DHCP relay will add Option 82 to both messages due to different processing mechanisms of DHCP Servers of manufacturers for Request message. Some devices handle Option 82 in the DHCPDISCOVERY message, while others handle it in the DHCPREQUEST message.

A switch configured with DHCP Snooping and Option 82 functions receives DHCPREQUEST messages with Option 82 sent by DHCP Clients. DHCP Snooping takes different processing mechanisms according to different configuration processing strategies and sub-option contents.

Instructions:

1. Click the “Security > DHCP Snooping > Option82 Property”. Global and port configurations are contained. Select the port to be configured and “Edit” the details as follows:



The screenshot shows a configuration window for DHCP Snooping Option 82. It features a 'Remote ID' field with a 'User Defined' checkbox and an empty text input box. Below this is an 'Operational Status' section with a green background, containing a 'Remote ID' field with the value '1c:2a:a3:00:00:8f (Switch Mac in Byte Order)'. An 'Apply' button is located at the bottom left of the window.

## Port Setting Table

<input type="checkbox"/>	Entry	Port	State	Allow Untrust
<input type="checkbox"/>	1	GE1	Disabled	Drop
<input type="checkbox"/>	2	GE2	Disabled	Drop
<input type="checkbox"/>	3	GE3	Disabled	Drop
<input type="checkbox"/>	4	GE4	Disabled	Drop
<input type="checkbox"/>	5	GE5	Disabled	Drop
<input type="checkbox"/>	6	GE6	Disabled	Drop
<input type="checkbox"/>	7	GE7	Disabled	Drop

## Edit Port Setting

<b>Port</b>	GE1-GE2
<b>State</b>	<input type="checkbox"/> Enable
<b>Allow Untrust</b>	<input type="radio"/> Keep <input checked="" type="radio"/> Drop <input type="radio"/> Replace

Interface data are as follows.

Configuration Items	Description
Remote ID	Fill in the Remote ID fields in Option 82 (such as user-defined XXXX)
Port	Whether the port No. of Option 82 is enabled
Untrust Port Access	Untrust Port processes messages with Option 82 enabled: Maintaining: leave Option 82 in the message unchanged and forward it Discarding: discard the message Replacing: replace and forward the Option 82 field in the message according to the Circuit ID configuration



Description:

Option 82 field independently configures Circuit ID or Remote ID sub-options. It can be configured individually or simultaneously in no specific order. DHCP Option 82 must be configured in the user bar, otherwise DHCP messages sent to DHCP Server won't carry Option 82. When receiving the DHCP response message from DHCP Server, the message containing Option 82 will be forwarded after deleting the field, or forwarded directly if

the message contains no Option 82.

2. Fill in corresponding configuration items.
3. “Apply” and finish as follows.

The screenshot shows a configuration window with a 'Remote ID' field set to 'aaaaa' and a checked 'User Defined' option. Below this is an 'Operational Status' section with a 'Remote ID' field also set to 'aaaaa'. An 'Apply' button is located at the bottom of the configuration area.

### Port Setting Table

<input type="checkbox"/>	Entry	Port	State	Allow Untrust
<input type="checkbox"/>	1	GE1	Enabled	Replace
<input type="checkbox"/>	2	GE2	Enabled	Replace
<input type="checkbox"/>	3	GE3	Enabled	Replace
<input type="checkbox"/>	4	GE4	Disabled	Drop
<input type="checkbox"/>	5	GE5	Disabled	Drop

### Illustration of DHCP Snooping Typical Configuration

As shown below, Switch port GE1-5 is connected to DHCP Server, and ports GE1-1, 2 and 3 are connected to DHCP Client A, B and C respectively.

- Enable the DHCP Snooping on the switch.
- Set the GE1-5 as the trust port of DHCP Snooping.
- Enable the Option 82 supporting function on the switch. For GE1-3 message flowing through the port, fill in the Option 82 according to the default configuration of Circuit ID and Remote ID.

**Network Diagram**

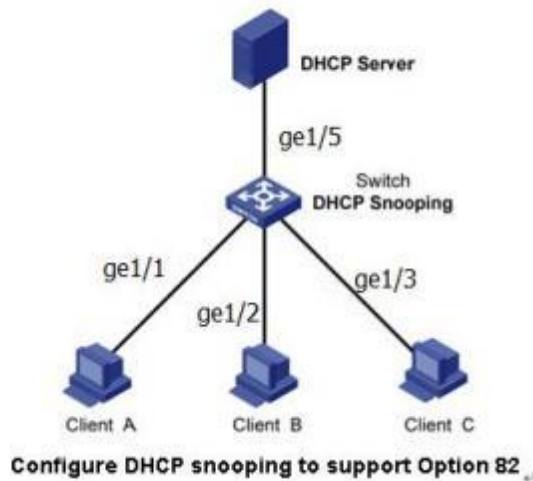

Instructions:

1. Enable the DHCP Snooping of switch. Click the “Security > DHCP Snooping > Property” in the navigation bar to enable the function as follows:

2. Set the GE1-5 as the trust port of DHCP Snooping, fill in corresponding configurations and “Edit” as follows:

**Port Setting Table**

<input type="checkbox"/>	Entry	Port	Trust	Verify Chaddr	Rate Limit
<input type="checkbox"/>	1	GE1	Enabled	Disabled	Unlimited
<input type="checkbox"/>	2	GE2	Enabled	Disabled	Unlimited
<input type="checkbox"/>	3	GE3	Enabled	Disabled	Unlimited
<input type="checkbox"/>	4	GE4	Enabled	Disabled	Unlimited
<input type="checkbox"/>	5	GE5	Enabled	Disabled	Unlimited

3. Configure on the port GE3 so that user defined remote ID can be set by Option 82.

Click the “Security > DHCP Snooping > Option82 Property”, check and configure the port. “Apply” and finish as follows:

#### Port Setting Table

Entry	Port	State	Allow Untrust
1	GE1	Disabled	Drop
2	GE2	Disabled	Drop
3	GE3	Enabled	Replace
4	GE4	Disabled	Drop
5	GE5	Disabled	Drop

- Configure on the port GE3 so that the circuit ID can be set by Option 82. Click the “Security > DHCP Snooping > Option82 Circuit ID” to configure the port. “Apply” and finish as follows:

#### Option82 Circuit ID Table

Showing All entries      Showing 1 to 1 of 1 entries

Port	VLAN	Circuit ID
GE3	1	ge1/3

Buttons: Add, Edit, Delete, First, Previous, 1, Next, Last

## 13.9 IP Source Guard

IP source guard (IPSG) is a port traffic filtering technology based on IP / Mac, which can prevent IP address spoofing attacks in LAN. IPSG can ensure that the IP address of the terminal device in the layer 2 network will not be hijacked, and it can also ensure that the unauthorized device cannot access the network or attack the network through its own specified IP address, resulting in network crash and paralysis

### 13.9.1 Port Setting

Instructions

- Click the “Security > IP Source Guard > Port Setting” enter port configuration interface

as follows:

### Port Setting Table

<input type="checkbox"/>	Entry	Port	State	Verify Source	Current Entry	Max Entry
<input type="checkbox"/>	1	GE1	Disabled	IP	0	Unlimited
<input type="checkbox"/>	2	GE2	Disabled	IP	0	Unlimited
<input type="checkbox"/>	3	GE3	Disabled	IP	0	Unlimited
<input type="checkbox"/>	4	GE4	Disabled	IP	0	Unlimited
<input type="checkbox"/>	5	GE5	Disabled	IP	0	Unlimited
<input type="checkbox"/>	6	GE6	Disabled	IP	0	Unlimited
<input type="checkbox"/>	7	GE7	Disabled	IP	0	Unlimited
<input type="checkbox"/>	8	GE8	Disabled	IP	0	Unlimited

#### Edit Port Setting

Port	GE1-GE2
State	<input type="checkbox"/> Enable
Verify Source	<input checked="" type="radio"/> IP <input type="radio"/> IP-MAC
Max Entry	<input style="width: 80px;" type="text" value="0"/> <small>(1 - 50, default 0), 0 is Unlimited</small>

Interface data are as follows.

Configuration Items	Description
Port	Port list
State	Enable or disable IPSPG
Verify Source	Default IP Source Guard filter source IP address. The "IP-MAC" filters not only source IP address but also source MAC address
Max Entry	Maximum number of ports allowed

### 13.9.2 IMPV Binding

In DHCP network, users (non-DHCP users) obtaining IP addresses statically may attack the network by imitating DHCP Server, constructing DHCP Request message, etc. Legal DHCP users may suffer from security risks when using the network normally.

Enabling the static MAC entries based on the interface generated by DHCP

Snooping binding table can prevent such attacks. The device then, based on the DHCP Snooping binding table corresponding to all DHCP users, automatically executes the command to generate static MAC entries and disable the interface's learning ability of dynamic entries. Only messages that match the source MAC and static MAC entries can flow through the interface. Therefore, for non-DHCP users, only the messages of static MAC entries that are manually configured by the administrators can flow through, while others will be discarded.

Instructions:

1. Click the "Security > IP Source Guard > IMPV Binding", "Add" a new binding group of IP-MAC-Port-VLAN as follows:

**IP-MAC-Port-VLAN Binding Table**

Showing All entries      Showing 0 to 0 of 0 entries     

<input type="checkbox"/>	Port	VLAN	MAC Address	IP Address	Binding	Type	Lease Time
0 results found.							

First Previous **1** Next Last

Add Edit Delete

---

**Add IP-MAC-Port-VLAN Binding**

Port	GE1
VLAN	<input type="text"/> (1 - 4094)
Binding	<input checked="" type="radio"/> IP-MAC-Port-VLAN <input type="radio"/> IP-Port-VLAN
MAC Address	<input type="text"/>
IP Address	<input type="text"/> / 255.255.255.255

Apply Close

Interface data are as follows.

Configuration Items	Description
Port	The port No. of binding group
VLAN	VLAN ID bound
Binding	Select the binding relation from IPMV and IPV
MAC Address	MAC address bound
IP Address	IP address bound

2. Fill in corresponding configuration items.
3. "Apply" and finish as follows.

**IP-MAC-Port-VLAN Binding Table**

Showing  entries      Showing 1 to 1 of 1 entries     

<input type="checkbox"/>	Port	VLAN	MAC Address	IP Address	Binding	Type	Lease Time
<input type="checkbox"/>	GE1	1	00:00:11:11:22:22	192.168.1.123 / 255.255.255.255	IP-MAC-Port-VLAN	Static	N/A

4. Click the “Security > IP Source Guard > Save Database” enter database interface as follows:

Type	<input checked="" type="radio"/> None <input type="radio"/> Flash <input type="radio"/> TFTP
Filename	<input type="text"/>
Address Type	<input checked="" type="radio"/> Hostname <input type="radio"/> IPv4
Server Address	<input type="text"/>
Write Delay	<input type="text" value="300"/> Sec (15 - 86400, default 300)
Timeout	<input type="text" value="300"/> Sec (0 - 86400, default 300)

## 14 ACL

Expanding network scale and mounting flow strengthen the position of network security control and bandwidth allocation. Packet filtering prevents illegal users from accessing, control flow and saves network resources. ACL (Access Control List) filters packets by configuring the message matching rules and processing methods.

The switch port receiving messages analyzes the field according to the current ACL rules. Once a specific message is identified, it will be allowed or forbidden to flow through according to predetermined policies.

The packet matching rules defined by ACL can also be referenced by other functions requiring flow distinction such as the definition of QoS flow classification rules. ACL can filter packets by setting matching rules and processing methods. ACL is a collection of permission and denial conditions applicable to packets. When the interface receives the packets, the switch compares the fields and ACL to determine the permitted and denied packets subject to specified standards. ACL classifies packets by matching conditions, which can be the source/destination MAC address, source/destination IP

address, port No. and so on. ACL classifies packets by matching conditions, which can be the source/destination address, port No., etc. ACL can be divided into the following categories according to application purposes:

Basic IP ACL formulates rules based only on the source IP address of packets. ACL ID ranges from 100 to 999. Advanced IP ACL prepares rules according to packets' source/destination IP address, protocol types carried by IP, and Layer 3 or 4 info such as protocol characteristics. ACL ID ranges from 100 to 999.

L2 ACL: Rules are made according to the packets' source/destination MAC address, 802.1p priority, and L2 info such as protocol type. ACL ID ranges from 1 to 99.

## 14.1 MAC ACL

L2 ACL: Rules are made according to source/destination MAC address, VLAN priority, and L2 info such as protocol type.

Instructions:

1. Click on the "ACL > MAC ACL" in the navigation bar as follows.

Interface data are as follows.

Configuration Items	Description
ACL Name	Name the MAC ACL Rules

2. Click on the "ACL > MAC ACE" in the navigation bar, "Add" the ACL name as follows:

Interface data are as follows.

Configuration Items	Description
ACL Name	ACL rule list is prepared based on MAC ACL configuration.

3. Fill in corresponding configuration items.

**Add ACE**

<b>ACL Name</b>	a	
<b>Sequence</b>	1	(1 - 2147483647)
<b>Action</b>	<input checked="" type="radio"/> Permit <input type="radio"/> Deny <input type="radio"/> Shutdown	
<b>Source MAC</b>	<input type="checkbox"/> Any <input type="text" value="00:00:00:00:20:00"/> / <input type="text" value="FF:FF:FF:FF:00"/> (Address / Mask)	
<b>Destination MAC</b>	<input type="checkbox"/> Any <input type="text" value="00:00:00:00:10:00"/> / <input type="text" value="FF:FF:FF:FF:00"/> x (Address / Mask)	
<b>Ethertype</b>	<input checked="" type="checkbox"/> Any <input type="text" value="0x"/> (0x600 ~ 0xFFFF)	
<b>VLAN</b>	<input checked="" type="checkbox"/> Any <input type="text"/> (1 - 4094)	
<b>802.1p</b>	<input checked="" type="checkbox"/> Any <input type="text"/> / <input type="text"/> (Value / Mask) (0 - 7)	

Apply Close

Interface data are as follows.

Configuration Items	Description
ACL Name	ACL rule list is prepared based on MAC ACL configuration.
Sequence	MAC ACL ranges from 1 to 2,147,483,647
Action	ACL actions are divided into "Permit" or "Deny", as well as "Shutdown".
Source MAC	Enter the source MAC address and mask of ACL rules with the format of H.H.H.H.H.H. Select "Any" to represent any MAC address
Destination MAC	Enter the destination MAC address and mask of ACL rules with the format of H.H.H.H.H.H. Select "Any" to represent any MAC address
EtherType	Enter the Ethernet type of ACL rules ranging from 0 x 600 to 0 x FFFF, select "Any" to represent any type.
VLAN	Enter the VLAN of ACL rules ranging from 1 to 4,094, select "Any" to represent any VLAN
802.1p	Enter the VLAN priority and mask of ACL rules ranging from 1 to 7, select "Any" to represent any VLAN priority

4. "Apply" and finish as follows.



## 14.2 IPv4 ACL

IPv4-based ACL (Basic IP ACL) formulates rules as per the source IP address of packets only. ACL ID ranges from 100 to 999.

Advanced IP ACL Rules are made according to the packets' source/destination IP address, protocol type carried by IP, and Layer 3 or 4 info such as protocol characteristics. ACL ID ranges from 100 to 999.

Instructions

1. Click on the "ACL > IPv4 ACL" in the navigation bar as follows.



Interface data are as follows.

Configuration Items	Description
ACL Name	Name the IPv4 ACL rules

2. Click on the "ACL > IPv4 ACE" in the navigation bar, "Add" the ACL Name as follows:



Interface data are as follows.

Configuration Items	Description
ACL Name	ACL rule list is made based on IPv4 ACL configuration.

3. Fill in corresponding configuration items.

Add ACE

<b>ACL Name</b>	B
<b>Sequence</b>	100 (1 - 2147483647)
<b>Action</b>	<input checked="" type="radio"/> Permit <input type="radio"/> Deny <input type="radio"/> Shutdown
<b>Protocol</b>	<input checked="" type="radio"/> Any <input type="radio"/> Select ICMP <input type="radio"/> Define (0 - 255)
<b>Source IP</b>	<input checked="" type="checkbox"/> Any <input type="text"/> / <input type="text"/> (Address / Mask)
<b>Destination IP</b>	<input checked="" type="checkbox"/> Any <input type="text"/> / <input type="text"/> (Address / Mask)
<b>Type of Service</b>	<input checked="" type="radio"/> Any <input type="radio"/> DSCP (0 - 63) <input type="radio"/> IP Precedence (0 - 7)
<b>Source Port</b>	<input checked="" type="radio"/> Any <input type="radio"/> Single (0 - 65535) <input type="radio"/> Range - (0 - 65535)
<b>Destination Port</b>	<input checked="" type="radio"/> Any <input type="radio"/> Single (0 - 65535) <input type="radio"/> Range - (0 - 65535)
<b>TCP Flags</b>	Urg: <input type="radio"/> Set <input type="radio"/> Unset <input checked="" type="radio"/> Don't care Ack: <input type="radio"/> Set <input type="radio"/> Unset <input checked="" type="radio"/> Don't care Psh: <input type="radio"/> Set <input type="radio"/> Unset <input checked="" type="radio"/> Don't care Rst: <input type="radio"/> Set <input type="radio"/> Unset <input checked="" type="radio"/> Don't care Syn: <input type="radio"/> Set <input type="radio"/> Unset <input checked="" type="radio"/> Don't care Fin: <input type="radio"/> Set <input type="radio"/> Unset <input checked="" type="radio"/> Don't care
<b>ICMP Type</b>	<input checked="" type="radio"/> Any <input type="radio"/> Select Echo Reply <input type="radio"/> Define (0 - 255)
<b>ICMP Code</b>	<input checked="" type="radio"/> Any <input type="radio"/> Define (0 - 255)

Apply Close

Interface data are as follows.

Configuration Items	Description
ACL Name	ACL rule list is made based on IPv4 ACL configuration.
Sequence	IPv4 ACL ranges from 1 to 2,147,483,647.
Action	ACL actions are divided into "Permit" or "Deny", as well as "Shutdown".

Protocol	It is required to select the protocol type such as ICMP, TCP and UDP. Select “Any” to represent any protocol.
Source IP	Enter the source IP and mask of ACL rules. Select “Any” to represent any source IP.
Destination IP	Enter the destination IP and mask of ACL rules. Select “Any” to represent any destination IP.
Type of Service	Enter the service type of ACL rules, such as DSCP (0-63) and IP priority (0-7). Select “Any” to represent any service type.
Source Port	Enter the source port of ACL rules, such as single port No. or range segment (0-65,535). Select “Any” to represent any source port.
Destination Port	Enter the destination port of ACL rules, such as single port No. or range segment (0-65,535). Select “Any” to represent any destination port.
TCP Flags	Enter the TCP flags of ACL rules, such as URG, ACK, PSH, RST, SYN, FIN, with the actions such as “Set”, “Unset” and “Don’t care”.
ICMP Type	Enter the ICMP message type of ACL rules. Select “Any” to represent any ICMP type.
ICMP Code	Enter the ICMP Code value of ACL rules. Select “Any” to represent any field value.

3. “Apply” and finish as follows.



## 14.3 IPv6 ACL

Instructions

1. Click the “ACL > IPv6 ACL” in the navigation bar as follows.

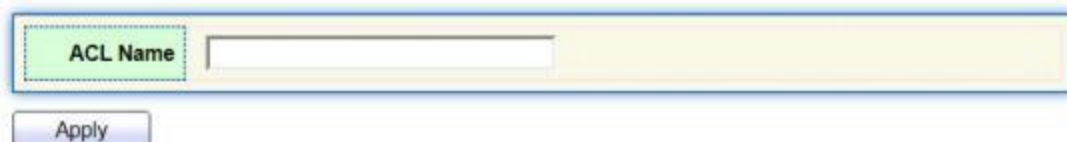

Interface data are as follows.

Configuration Items	Description
---------------------	-------------

ACL Name	Name the IPv6 ACL rules
----------	-------------------------

2. Click the “ACL > IPv6 ACE” in the navigation bar, “Add” the ACL Name as follows:



Interface data are as follows.

Configuration Items	Description
ACL Name	ACL rule list is made based on IPv6 ACL configuration.

3. Fill in corresponding configuration items

Add ACE

ACL Name	b
Sequence	100 (1 - 2147483647)
Action	<input checked="" type="radio"/> Permit <input type="radio"/> Deny <input type="radio"/> Shutdown
Protocol	<input checked="" type="radio"/> Any <input type="radio"/> Select <span>TCP</span> <input type="radio"/> Define <span></span> (0 - 255)
Source IP	<input checked="" type="checkbox"/> Any <input type="checkbox"/> <span></span> / <span></span> (Address / Prefix (0 - 128))
Destination IP	<input checked="" type="checkbox"/> Any <input type="checkbox"/> <span></span> / <span></span> (Address / Prefix (0 - 128))
Type of Service	<input checked="" type="radio"/> Any <input type="radio"/> DSCP <span></span> (0 - 63) <input type="radio"/> IP Precedence <span></span> (0 - 7)
Source Port	<input checked="" type="radio"/> Any <input type="radio"/> Single <span></span> (0 - 65535) <input type="radio"/> Range <span></span> - <span></span> (0 - 65535)
Destination Port	<input checked="" type="radio"/> Any <input type="radio"/> Single <span></span> (0 - 65535) <input type="radio"/> Range <span></span> - <span></span> (0 - 65535)
TCP Flags	Urg: <input type="radio"/> Set <input type="radio"/> Unset <input checked="" type="radio"/> Don't care Ack: <input type="radio"/> Set <input type="radio"/> Unset <input checked="" type="radio"/> Don't care Psh: <input type="radio"/> Set <input type="radio"/> Unset <input checked="" type="radio"/> Don't care Rst: <input type="radio"/> Set <input type="radio"/> Unset <input checked="" type="radio"/> Don't care Syn: <input type="radio"/> Set <input type="radio"/> Unset <input checked="" type="radio"/> Don't care Fin: <input type="radio"/> Set <input type="radio"/> Unset <input checked="" type="radio"/> Don't care
ICMP Type	<input checked="" type="radio"/> Any <input type="radio"/> Select <span>Destination Unreachable</span> <input type="radio"/> Define <span></span> (0 - 255)
ICMP Code	<input checked="" type="radio"/> Any <input type="radio"/> Define <span></span> (0 - 255)

Apply Close

Interface data are as follows.

Configuration Items	Description
ACL Name	ACL rule list is made based on IPv6 ACL configuration.
Sequence	IPv6 ACL ranges from 1 to 2,147,483,647.
Action	ACL actions are divided into "Permit" or "Deny", as well as "Shutdown".
Protocol	It is required to select the protocol type such as ICMP, TCP and UDP. Select "Any" to represent any protocol.

Source IP	Enter the source IP and mask of ACL rules. Select “Any” to represent any source IP.
Destination IP	Enter the destination IP and mask of ACL rules. Select “Any” to represent any destination IP.
Type of Service	Enter the service type of ACL rules, such as DSCP (0-63) and IP priority (0-7). Select “Any” to represent any service type.
Source Port	Enter the source port of ACL rules, such as single port No. or range segment (0-65,535). Select “Any” to represent any source port.
Destination Port	Enter the destination port of ACL rules, such as single port No. or range segment (0-65,535). Select “Any” to represent any destination port.
TCP Flags	Enter the TCP flags of ACL rules, such as URG, ACK, PSH, RST, SYN, FIN, with the actions such as “Set”, “Unset” and “Don’t care”.
ICMP Type	Enter the ICMP message type of ACL rules. Select “Any” to represent any ICMP type.
ICMP Code	Enter the ICMP code value of ACL rules. Select “Any” to represent any field value.

4. “Apply” and finish as follows.

**ACE Table**

ACL Name

Showing  entries      Showing 1 to 1 of 1 entries

Sequence	Action	Protocol	Source IP		Destination IP		Source Port	Destination Port	TCP Flags	Type of Service		ICMP	
			Address	Prefix	Address	Prefix				DSCP	IP Precedence	Type	Code
<input type="checkbox"/>	100	Permit	Any (IP)	Any	Any	Any				Any		Any	

## 14.4 ACL Binding

Once the list is created, it must be bound to each required interface.

Instructions:

1. Click the “ACL > ACL Binding” in the navigation bar as follows.

**ACL Binding Table**

Entry	Port	MAC ACL	IPv4 ACL	IPv6 ACL
<input type="checkbox"/>	1	GE1		
<input type="checkbox"/>	2	GE2		
<input type="checkbox"/>	3	GE3		
<input type="checkbox"/>	4	GE4		

Interface data are as follows.

Configuration Items	Description
MAC ACL	MAC ACL name bound to the port
IPv4 ACL	IPv4 ACL name bound to the port (mutually exclusive with IPv6 ACL)
IPv6 ACL	IPv6 ACL name bound to the port (mutually exclusive with IPv4 ACL)

- Fill in corresponding configuration items, taking the created MAC ACL a, IPv4 ACL b, IPv6 ACL c as examples.
- “Apply” and finish as follows.

#### Add ACL Binding

The screenshot shows a configuration window titled "Add ACL Binding". It contains a form with the following fields:

- Port:** GE3
- MAC ACL:** a
- IPv4 ACL:** b
- IPv6 ACL:** None

A note below the Port field reads: "Note: ACL without any rules cannot be bound". At the bottom of the window, there are two buttons: "Apply" and "Close".

## 15 QoS

QoS (Quality of Service) assesses the ability of service providers to meet customer needs and the ability of transmitting packets over the Internet. Diversified services can be assessed based on different aspects. QoS usually refers to the evaluation of service capabilities that support core requirements such as bandwidth, delay, delay variation, and packet loss rate during delivery. Bandwidth, also known as throughput, refers to the average business flow within a certain period of time, with the unit of Kbit/s. Delay refers to the average time required for business flowing through the network. For a network device, the followings are general levels of delay requirements. There are two delay levels, that is, the high-priority business can be served as soon as possible by scheduling method of priority queue, while the low-priority business gets services after that. Delay variation refers to the time change of business flowing through the network. Packet loss rate refers to the percentage of lost business flow during transmission. As modern transmission systems are very reliable, information is often lost in network congestion.

Packet loss due to queue overflow is the most common situation.

All messages in a traditional IP network are treated equally. Every network device processes the messages on a FIFO basis, and makes every effort to transmit them to destinations without guaranteeing reliability, transfer delay, or other performance.

Network service quality is constantly improved as new applications keep springing up in the rapidly changing IP network. For example, VoIP, video and other delay-sensitive services have set higher standards on message transmission delay. Message transmission in a short period has been the common trend. In order to support voice, video and data services with different requirements, the network needs to identify business types and provide corresponding services.

The ability to distinguish business types is the prerequisite to provide corresponding services, so the traditional best-effort service no longer meets the application needs. Therefore, QoS comes into being. It regulates the network flow to avoid and handle network congestion and reduce packet loss rate. Meanwhile, users can enjoy dedicated bandwidths while business can improve service quality, thus perfecting the network service capacity.

QoS priorities vary with message types. For instance, the VLAN message uses 802.1p, also known as the CoS (Class of Service) field, while the IP message uses DSCP. To maintain the priority, these fields need to be mapped at the gateway connected with various networks when messages flow through the network.

802.1p priority in the VLAN frame header

Typically, VLAN frames are interacted between Layer 2 devices. The PRI field (i.e. 802.1p priority), or CoS field, in the VLAN frame header identifies the quality of service requirements according to the definitions in IEEE 802.1Q.

802.1p priority in the VLAN frame

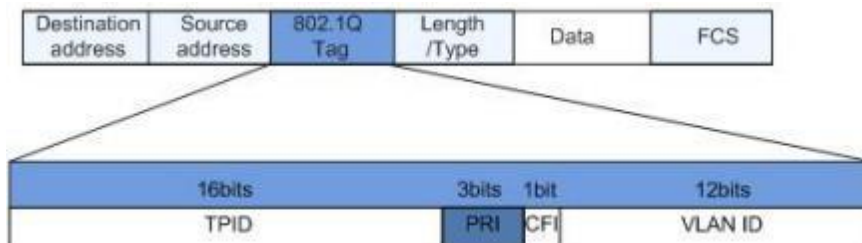

The 802.1Q header contains 3-bit PRI fields. PRI field defines 8 CoS of business priority ranging from 7 to 0 from high to low.

IP Precedence/DSCP Field

According to RFC791 definition, ToS (Type of Service) domain in the IP message header is composed of 8 bits. Among them, the 3-bit long Precedence field, as located in the following, identifies the IP message priority.

IP Precedence/DSCP Field

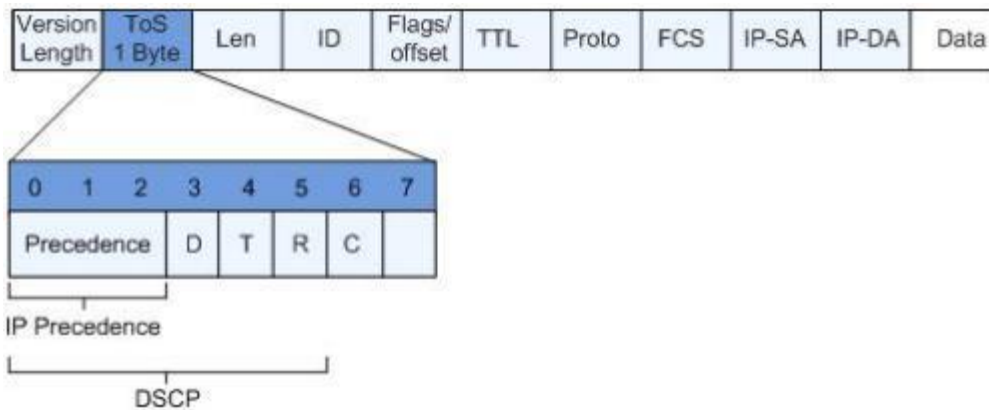

0 to 2 bits are Precedence fields representing the 8 priorities of message transmission ranging from 7 to 0 from high to low, with either Level 7 or 6 as the highest priority that is generally reserved for routing or updating network control communication. User-level applications only have access to Level 0 to 5.

ToS domain, in addition to Precedence fields, also includes D, T and R bits: D-bit represents the Delay requirement (0 for normal delay and 1 for low delay). T-bit represents the throughput (0 for normal throughput and 1 for high throughput). R-bit represents the reliability (0 for normal reliability and 1 for high reliability). ToS domain reserves the 6 and 7 bits.

RFC1349 redefines the ToS domain by adding a C-bit to represent the Monetary Cost. The IETF DiffServ group then redefines the 0 to 5 bits of ToS domain in the IPv4 message header of RFC2474 as DSCP and renames it as DS (Differentiated Service) byte as shown in the figure above.

The first 6 bits (0-5 bits) of DS field distinguish the DSCP (DS Code Point), and the higher 2 bits (6-7 bits) are reserved. The lower 3 bits (0-2 bits) are CSCP (Class Selector Code Point), with the same CSCP value representing the DSCP of the same class. DS nodes select corresponding PHB (Per-Hop Behavior) according to DSCP values.

## 15.1 General

### 15.1.1 Property

Network congestion resulting from the competition for resource use rights among messages at the same time is usually solved by queue scheduling, thus avoiding intermittent congestions. Queue scheduling technologies include SP (Strict-Priority), WFQ (Weighted Fair Queue), WRR (Weighted Round Robin), and DRR (Deficit Round Robin, which is also expanded from RR technology).

Instructions for global and port scheduling configuration

1. Click the "QoS > General > Property" in the navigation bar as follows.

**State**

**Trust Mode**

Enable  
 CoS  
 DSCP  
 CoS-DSCP  
 IP Precedence

### Port Setting Table

Entry	Port	CoS	Trust	Remarking			
				CoS	DSCP	IP Precedence	
<input type="checkbox"/>	1	GE1	0	Enabled	Disabled	Disabled	Disabled
<input type="checkbox"/>	2	GE2	0	Enabled	Disabled	Disabled	Disabled
<input type="checkbox"/>	3	GE3	0	Enabled	Disabled	Disabled	Disabled
<input type="checkbox"/>	4	GE4	0	Enabled	Disabled	Disabled	Disabled

Interface data of global configuration are as follows.

Configuration Items	Description
State	Switch of global QoS function
Trust Mode	It can be divided into CoS, DSCP, CoS-DSCP and IP priority

Interface data of port configuration are as follows.

Configuration Items	Description
CoS	Ranging from 0 to 7
Port Trust Mode	Switch of port QoS function
CoS	Mark the CoS field
DSCP	Mark the DSCP field
IP Priority	Mark the IP Priority field

### 15.1.2 Queue Scheduling

1. Click the “QoS > General > Queue Scheduling”. “Apply” and finish as follows.

## Queue Scheduling Table

Queue	Method			
	Strict Priority	WRR	Weight	WRR Bandwidth (%)
1	<input checked="" type="radio"/>	<input type="radio"/>	1	
2	<input checked="" type="radio"/>	<input type="radio"/>	2	
3	<input checked="" type="radio"/>	<input type="radio"/>	3	
4	<input checked="" type="radio"/>	<input type="radio"/>	4	
5	<input checked="" type="radio"/>	<input type="radio"/>	5	
6	<input checked="" type="radio"/>	<input type="radio"/>	9	
7	<input checked="" type="radio"/>	<input type="radio"/>	13	
8	<input checked="" type="radio"/>	<input type="radio"/>	15	

Apply

Interface data are as follows.

Configuration Items	Description
Strict Priority	SP mode
WRR	WRR mode
Weight	Bandwidth percentage of WRR accounted for by Queue

### 15.1.3 CoS Mapping

1. Click the "QoS > General > CoS Mapping" in the navigation bar. "Apply" and finish as follows.

### CoS to Queue Mapping

CoS	Queue	
0	1 ▼	
1	2 ▼	
2	3 ▼	
3	4 ▼	
4	5 ▼	
5	6 ▼	
6	7 ▼	
7	8 ▼	

Apply

### Queue to CoS Mapping

Queue	CoS	
1	0 ▼	
2	1 ▼	
3	2 ▼	
4	3 ▼	
5	4 ▼	
6	5 ▼	
7	6 ▼	
8	7 ▼	

Apply

Interface data are as follows.

Configuration Items	Description
CoS	802.1p priority
Queue	Port queue

### 15.1.4 DSCP Mapping

1. Click the “QoS > General > DSCP Mapping”. “Apply” and finish as follows.

### DSCP to Queue Mapping

DSCP	Queue	DSCP	Queue	DSCP	Queue	DSCP	Queue
0 [CS0]	1 ▼	16 [CS2]	3 ▼	32 [CS4]	5 ▼	48 [CS6]	7 ▼
1	1 ▼	17	3 ▼	33	5 ▼	49	7 ▼
2	1 ▼	18 [AF21]	3 ▼	34 [AF41]	5 ▼	50	7 ▼
3	1 ▼	19	3 ▼	35	5 ▼	51	7 ▼
4	1 ▼	20 [AF22]	3 ▼	36 [AF42]	5 ▼	52	7 ▼
5	1 ▼	21	3 ▼	37	5 ▼	53	7 ▼
6	1 ▼	22 [AF23]	3 ▼	38 [AF43]	5 ▼	54	7 ▼
7	1 ▼	23	3 ▼	39	5 ▼	55	7 ▼
8 [CS1]	2 ▼	24 [CS3]	4 ▼	40 [CS5]	6 ▼	56 [CS7]	8 ▼
9	2 ▼	25	4 ▼	41	6 ▼	57	8 ▼
10 [AF11]	2 ▼	26 [AF31]	4 ▼	42	6 ▼	58	8 ▼
11	2 ▼	27	4 ▼	43	6 ▼	59	8 ▼
12 [AF12]	2 ▼	28 [AF32]	4 ▼	44	6 ▼	60	8 ▼
13	2 ▼	29	4 ▼	45	6 ▼	61	8 ▼
14 [AF13]	2 ▼	30 [AF33]	4 ▼	46 [EF]	6 ▼	62	8 ▼
15	2 ▼	31	4 ▼	47	6 ▼	63	8 ▼

Apply

### Queue to DSCP Mapping

Queue	DSCP
1	0 [CS0] ▼
2	8 [CS1] ▼
3	16 [CS2] ▼
4	24 [CS3] ▼
5	32 [CS4] ▼
6	40 [CS5] ▼
7	48 [CS6] ▼
8	56 [CS7] ▼

Apply

Interface data are as follows.

Configuration Items	Description
DSCP	Value of IP DHCP domain priority
Queue	Port queue

### 15.1.5 IP Precedence Mapping

1. Click the “QoS > General > IP Precedence Mapping”, enter this page and click “Apply”, finish as follows.

#### IP Precedence to Queue Mapping

IP Precedence	Queue
0	1 ▼
1	2 ▼
2	3 ▼
3	4 ▼
4	5 ▼
5	6 ▼
6	7 ▼
7	8 ▼

Apply

#### Queue to IP Precedence Mapping

Queue	IP Precedence
1	0 ▼
2	1 ▼
3	2 ▼
4	3 ▼
5	4 ▼
6	5 ▼
7	6 ▼
8	7 ▼

Apply

Interface data are as follows.

Configuration Items	Description
IP Precedence	Value of IP TOS domain priority
Queue	Port queue

## 15.2 Rate limit

### 15.2.1 Ingress / Egress Port

It refers to the rate restriction on transmitting and receiving data at physical interfaces.

Restrict the rate limiting at the egress before transmitting flow, thus controlling all outgoing message flow;

Restrict the rate limiting at the ingress before receiving flow, thus controlling all incoming message flow;

Instructions:

1. Click the “QoS > Rate Limit > Ingress / Egress Port” in the navigation bar to choose a rate-limiting port and check the current configuration as follows:

#### Ingress / Egress Port Table



Entry	Port	Ingress		Egress	
		State	Rate (Kbps)	State	Rate (Kbps)
<input type="checkbox"/>	1	GE1	Disabled	Disabled	
<input type="checkbox"/>	2	GE2	Disabled	Disabled	
<input type="checkbox"/>	3	GE3	Disabled	Disabled	
<input type="checkbox"/>	4	GE4	Disabled	Disabled	
<input type="checkbox"/>	5	GE5	Disabled	Disabled	
<input type="checkbox"/>	6	GE6	Disabled	Disabled	
<input type="checkbox"/>	7	GE7	Disabled	Disabled	

2. Select the port (s) for rate limiting, “Edit” it at the bottom to switch the function and specify the rate. “Apply” and finish as follows:

#### Edit Ingress / Egress Port



Port	GE1-GE3
Ingress	<input checked="" type="checkbox"/> Enable <input type="text" value="1000000"/> Kbps (16 - 1000000)
Egress	<input checked="" type="checkbox"/> Enable <input type="text" value="1000000"/> Kbps (16 - 1000000)

Interface data are as follows.

Configuration Items		Description
Ingress	Enabled	Rate limiting switch
	Rate	Rate ranges from 16 to 1,000,000 Kbps
Egress	Enabled	Rate limiting switch
	Rate	Rate ranges from 16 to 1,000,000 Kbps

## 15.2.2 Egress Queue

Instructions for egress queue configuration

1. Click the “QoS > Rate Limit > Egress Queue” in the navigation bar as follows.

Egress Queue Table

Entry	Port	Queue 1		Queue 2		Queue 3		Queue 4		Queue 5		Queue 6		Queue 7		Queue 8	
		State	CR (Kbps)	State	CR (Kbps)	State	CR (Kbps)	State	CR (Kbps)	State	CR (Kbps)	State	CR (Kbps)	State	CR (Kbps)	State	CR (Kbps)
1	GE1	Disabled		Disabled		Disabled		Disabled		Disabled		Disabled		Disabled		Disabled	
2	GE2	Disabled		Disabled		Disabled		Disabled		Disabled		Disabled		Disabled		Disabled	
3	GE3	Disabled		Disabled		Disabled		Disabled		Disabled		Disabled		Disabled		Disabled	
4	GE4	Disabled		Disabled		Disabled		Disabled		Disabled		Disabled		Disabled		Disabled	
5	GE5	Disabled		Disabled		Disabled		Disabled		Disabled		Disabled		Disabled		Disabled	
6	GE6	Disabled		Disabled		Disabled		Disabled		Disabled		Disabled		Disabled		Disabled	
7	GE7	Disabled		Disabled		Disabled		Disabled		Disabled		Disabled		Disabled		Disabled	
8	GE8	Disabled		Disabled		Disabled		Disabled		Disabled		Disabled		Disabled		Disabled	

2. Select the port and “Edit” to enter the port configuration interface as follows.

## Edit Egress Queue

Port	GE1-GE2
Queue 1	<input type="checkbox"/> Enable 1000000 Kbps (16 - 1000000)
Queue 2	<input type="checkbox"/> Enable 1000000 Kbps (16 - 1000000)
Queue 3	<input type="checkbox"/> Enable 1000000 Kbps (16 - 1000000)
Queue 4	<input type="checkbox"/> Enable 1000000 Kbps (16 - 1000000)
Queue 5	<input type="checkbox"/> Enable 1000000 Kbps (16 - 1000000)
Queue 6	<input type="checkbox"/> Enable 1000000 Kbps (16 - 1000000)
Queue 7	<input type="checkbox"/> Enable 1000000 Kbps (16 - 1000000)
Queue 8	<input type="checkbox"/> Enable 1000000 Kbps (16 - 1000000)

## 16 Diagnostics

### 16.1 Logging

It configures log switch, info integration, aging time and configuration level. It also uploads the switch's work logs to the TFTP Server.

Instructions:

1. Click the "Diagnostics > Logging > Property" in the navigation bar to switch logs enable/disable, select the egress terminal, configure the severity level, etc. as follows:

**State** Enable

**Aggregation** Enable

**Aging Time**  Sec (15 - 3600, default 300)

---

**Console Logging**

**State** Enable

**Minimum Severity** 
  
Note: Emergency, Alert, Critical, Error, Warning, Notice

---

**RAM Logging**

**State** Enable

**Minimum Severity** 
  
Note: Emergency, Alert, Critical, Error, Warning, Notice

---

**Flash Logging**

**State** Enable

**Minimum Severity** 
  
Note: Emergency, Alert, Critical, Error, Warning, Notice

- Click the “Diagnostics > Logging > Remote Server” in the navigation bar to add and view the server configuration as follows:

**Remote Server Table**

<input type="checkbox"/>	Entry	Server Address	Server Port	Facility	Minimum Severity
0 results found.					

- “Add” a new remote log server and “Edit” the selected configuration. “Apply” and finish as follows:

### Add Remote Server

<b>Address Type</b>	<input checked="" type="radio"/> Hostname <input type="radio"/> IPv4 <input type="radio"/> IPv6
<b>Server Address</b>	<input type="text"/>
<b>Server Port</b>	<input type="text" value="514"/> (1 - 65535, default 514)
<b>Facility</b>	<input type="text" value="Local 7"/>
<b>Minimum Severity</b>	<input type="text" value="Notice"/> <small>Note: Emergency, Alert, Critical, Error, Warning, Notice</small>

## 16.2 Ping

Ping command checks the availability of specified IP addresses and host names and transmits statistics accordingly.

Instructions:

1. Click the “Diagnostics > Ping” in the navigation bar to enter a host name or an IP address, as well as the number of tests as follows:

<b>Address Type</b>	<input type="radio"/> Hostname <input checked="" type="radio"/> IPv4 <input type="radio"/> IPv6
<b>Server Address</b>	<input type="text" value="192.168.1.111"/>
<b>Count</b>	<input type="text" value="4"/> (1 - 65535)

2. Click the “Ping” to accept the packet-transmitting test from system to verify address validity, and output the result as follows:

## Ping Result

Packet Status	
Status	Success.
Transmit Packet	4
Receive Packet	4
Packet Lost	0 %

Round Trip Time	
Min	0 ms
Max	0 ms
Average	0 ms

## 16.3 Traceroute

Traceroute measures the duration from transmitting a small packet to receiving it back from the target device.

Instructions:

1. Click the “Diagnostics > Traceroute” in the navigation bar to enter a host name or IP address to define the message existence time as follows:

Address Type	<input type="radio"/> Hostname
	<input checked="" type="radio"/> IPv4
Server Address	<input type="text" value="192.168.1.122"/>
Time to Live	<input type="checkbox"/> User Defined
	<input type="text" value="30"/> (2 - 255, default 30)

2. “Apply” to test and output the result as follows:

### Traceroute Result

```
traceroute to 192.168.1.122 (192.168.1.122), 30 hops max, 38 byte packets
1 192.168.1.122 (192.168.1.122) 0.000 ms 0.000 ms 0.000 ms
```

## 16.4 Copper Test

Copper test evaluates the ingress cable state and locates the faults (about 5 m by error) according to the reflected voltage strength

Instructions:

1. Click the “Diagnostics > Copper Test” in the navigation bar to select a port for test as follows:



Port GE1

Copper Test

2. Click the “Copper Test” and output the result as follows:

### Copper Test Result

Cable Status	
Port	GE1
Result	Open Cable
Length	2.92 M

## 16.5 Fiber Module

Can be used to view optical module DDM information

Instructions:

1. Click the “Diagnostics > Fiber Module” in the navigation bar to select a port for test as follows:

### Fiber Module Table

Port	Temperature (C)	Voltage (V)	Current (mA)	Output Power (mW)	Input Power (mW)	OE Present	Loss of Signal
<input type="radio"/> GE1	56.66	3.31	29.32	0.24	0.00	Remove	Normal
<input type="radio"/> GE2	N/S	N/S	N/S	N/S	N/S	Remove	Loss
<input type="radio"/> GE3	N/S	N/S	N/S	N/S	N/S	Remove	Loss
<input type="radio"/> GE4	N/S	N/S	N/S	N/S	N/S	Remove	Loss
<input type="radio"/> GE5	N/S	N/S	N/S	N/S	N/S	Remove	Loss

## 16.6 UDLD

UDLD (Unidirectional Link Detection): it is a Cisco private layer-2 protocol, which is used to monitor the physical configuration of Ethernet link connected by optical fiber or twisted pair. When one-way link appears (it can only transmit to one direction, for example, I can send data to you, you can also receive it, but I can't receive the data you sent to me), UDLD can detect this situation, close the corresponding interface and send it Warning message. One-way links may cause many problems, especially spanning trees, which may cause loopback. Note: UDLD needs to be supported by devices at both ends of the link to run normally.

### 16.6.1 Property

Global and port switch configuration

Instructions:

1. Click the "Diagnostics > UDLD > Property" in the navigation bar to select a port for test as follows:

Message Time

Sec (1 - 90, default 15)

### Port Setting Table

Entry	Port	Mode	Bidirectional State	Operational Status	Neighbor
<input type="checkbox"/> 1	GE1	Disabled	Unknown		0
<input type="checkbox"/> 2	GE2	Disabled	Unknown		0
<input type="checkbox"/> 3	GE3	Disabled	Unknown		0
<input type="checkbox"/> 4	GE4	Disabled	Unknown		0
<input type="checkbox"/> 5	GE5	Disabled	Unknown		0
<input type="checkbox"/> 6	GE6	Disabled	Unknown		0

2. Select the port and click “Edit” to enter the Edit interface as follows:



Interface data are as follows.

Configuration Items	Description
Port	Port id
Mode	UDLD port mode Disabled: Disable port function Normal: UDLD can detect one-way links and mark the port as undetermined to generate system logs Aggressive: UDLD can detect the unidirectional link. It will try to rebuild the link and send UDLD messages for 8 seconds continuously. If there is no UDLD echo response, the port will be placed in the errdisable state

### 16.6.2 Neighbor

UDLD periodically sends hello packets (also known as advertisement or probe probe) on each active interface.

When the Hello packet is received by the switch, the message is stored until the aging time is expired. When Hello is received again before the expiration of the aging time, the aging time is refreshed.

When a new neighbor or a neighbor requests to resynchronize the cache, a series of UDLD probe / echo (Hello) packets are sent.

Instructions:

1. Click the “Diagnostics > UDLD > Neighbor” in the navigation bar to select a port for test as follows:

## Neighbor Table

Entry	Expiration Time	Current Neighbor State	Device ID	Device Name	Port ID	Message Interval	Timeout Interval
0 results found.							

Refresh

Interface data are as follows.

Configuration Items	Description
Entry	Serial No. of neighbor
Expiration Time	Remaining aging time
Current Neighbor State	Status of neighbors
Device ID	Device id of neighbors
Device Name	Device name of neighbors
Port ID	The ID of the connected interface
Message Interval	Message interval for neighbors
Timeout Interval	Timeout interval for neighbors

## 17 Management

### 17.1 User Account

Users can check and modify the current username, password and authority of the switch.

Instructions:

1. Click the “Management > User Account” in the navigation bar to discover the username of “admin” and the privilege of “Admin” by default as follows:

Username	Privilege
admin	Admin

Add Edit Delete

First Previous 1 Next Last

2. “Add” a new user account and “Edit” the selected user attribute as follows:

### Add User Account

Username	<input type="text"/>
Password	<input type="password"/>
Confirm Password	<input type="password"/>
Privilege	<input checked="" type="radio"/> Admin <input type="radio"/> User

### Edit User Account

Username	admin
Password	<input type="password"/>
Confirm Password	<input type="password"/>
Privilege	<input checked="" type="radio"/> Admin <input type="radio"/> User

## 17.2 Firmware

System version firmware upgrade

Instructions:

1. Click the “Management > Firmware > Manual Upgrade” in the navigation bar as follows:

File Type	<input checked="" type="radio"/> Image
Action	<input checked="" type="radio"/> Upgrade
Method	<input type="radio"/> TFTP <input checked="" type="radio"/> HTTP
Filename	<input type="button" value="Choose File"/> No file chosen

## 17.3 Configuration

### 17.3.1 Manual Upgrade

System configuration upgrade or backup  
Instructions for configuration file upgrade:

1. Click the “Management > Configuration > Manual Upgrade” click the “Upgrade” in mode of “TFTP” or “HTTP”, select the corresponding files to be upgraded (servers should be illustrated in TFTP mode). “Apply” and finish as follows:

The screenshot shows a configuration window for a manual upgrade. It is divided into four sections: Action, Method, Configuration, and Filename. The Action section has 'Upgrade' selected. The Method section has 'HTTP' selected. The Configuration section has 'Running Configuration' selected. The Filename section has a 'Choose File' button and the text 'No file chosen'. An 'Apply' button is located below the form.

<b>Action</b>	<input checked="" type="radio"/> Upgrade <input type="radio"/> Backup
<b>Method</b>	<input type="radio"/> TFTP <input checked="" type="radio"/> HTTP
<b>Configuration</b>	<input checked="" type="radio"/> Running Configuration <input type="radio"/> Startup Configuration <input type="radio"/> Backup Configuration <input type="radio"/> RAM Log <input type="radio"/> Flash Log
<b>Filename</b>	<input type="button" value="Choose File"/> No file chosen

Instructions for file backup configuration:

2. click the “Backup” in mode of “TFTP” or “HTTP”, select the files or logs to be upgraded (servers should be illustrated in TFTP mode). “Apply” and finish as follows.

The screenshot shows a configuration window for file backup. It is divided into three sections: Action, Method, and Configuration. The Action section has 'Backup' selected. The Method section has 'HTTP' selected. The Configuration section has 'Running Configuration' selected. An 'Apply' button is located below the form.

<b>Action</b>	<input type="radio"/> Upgrade <input checked="" type="radio"/> Backup
<b>Method</b>	<input type="radio"/> TFTP <input checked="" type="radio"/> HTTP
<b>Configuration</b>	<input checked="" type="radio"/> Running Configuration <input type="radio"/> Startup Configuration <input type="radio"/> Backup Configuration <input type="radio"/> RAM Log <input type="radio"/> Flash Log

### 17.3.2 Save Configuration

Save system configuration or restore configuration to factory default  
Instructions:

1. Click the “Management > Configuration > Save Configuration” in the navigation bar as follows:

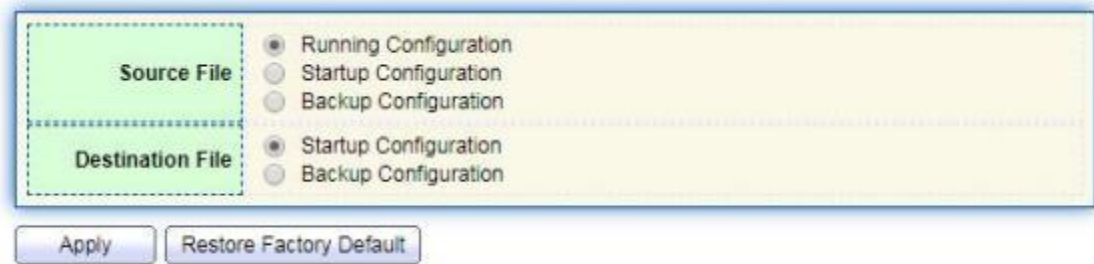

 **Note:**

- Click the “Factory Reset” and “Device Restart” to restore factory settings. Save the “Running Configuration” as the “Start Configuration” (which can be saved as “Backup Configuration” or “Running Configuration”) and the “Backup Configuration” (which can be saved as the “Start Configuration” or “Running Configuration”).

Instructions for the second method of system preservation:

2. Click the “Save” on the upper right to save the running configuration as the start configuration as follows.

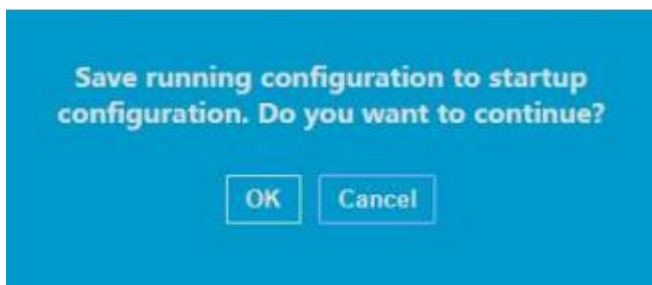

## 17.4 SNMP

SNMP (Simple Network Management Protocol) is widely used in TCP/IP network. It manages devices by the central computer which operates network management software (i.e. network management workstation). SNMP is:

- Simple: The polling-driving SNMP has the fundamental functionality set that is applicable to small-scale environment with fast speed and low cost. Besides, UDP-driven SNMP is compatible with most devices. Powerful: SNMP aims to ensure the management info transmission between two nodes so that administrators can retrieve, modify and troubleshoot the info easily. There are 3 common versions, namely SNMPv1, v2c and v3. Its system contains NMS (Network Management

System), Agent, Management object and MIB (Management Information Base).

- NMS, as the management center, will manage all devices. Each device under management includes the resident Agent, MIB and management objects. NMS interacts with the Agent running on the management object which will operate the MIB to execute NMS orders.

SNMP management model

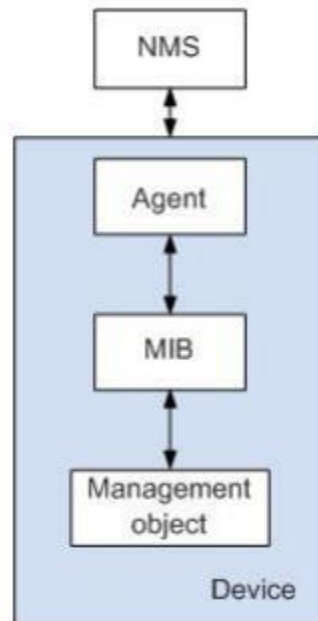

NMS

- As the network administrator, NMS manages/monitors network devices by SNMP on its server. It can request the Agent to inquire or modify specified parameter(s). NMS can receive the Trap actively sent by the Agent to be updated with the states of the managed devices.

Agent

- As an agent process of the managed devices, it maintains device data and responds to the NMS requests by reporting management data. Agent will fulfill relevant orders through MIB Table and transmit the results back to NMS after receiving its request. Devices will take the initiative to transmit info related to the current statuses of devices to NMS through Agent once a fault or another event occurs.

Management object

- It refers to the object under management. Each device may have more than one objects, including a piece of hardware (e.g. an interface board), partial hardware and software (e.g. routing protocol), as well as other configuration item sets

MIB

- MIB is a database specifying the variables maintained by the management object (i.e. the info that can be inquired and set by the Agent). MIB defines the attributes of the management object, including the name, state, access right and data type. The following functions can be realized through MIB: Agent will master the instant

device info by inquiring MIB and set the state configuration items by changing MIB.

### 17.4.1 View

1. Click the “Management > SNMP > View” in the navigation bar as follows.

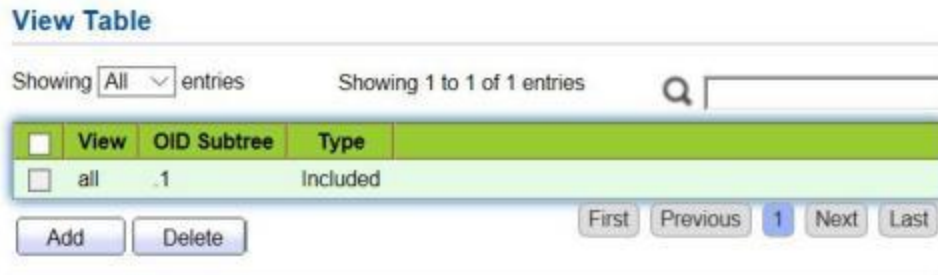

Interface data are as follows.

Configuration Items	Description
View	View name
OID Subtree	View OID
Type	View type: “Included” or “Excluded”

2. “Add” the corresponding configuration, “Apply” and finish.



### 17.4.2 Group

1. Click the “Management > SNMP > Group” in the navigation bar as follows.

## Group Table

Showing All entries      Showing 0 to 0 of 0 entries     

	Group	Version	Security Level	View		
				Read	Write	Notify
0 results found.						

Configure [SNMP View](#) to associate a non-default view with a group.

Interface data are as follows.

Configuration Items	Description
Group	Group name
Version	V1, V2, V3
Security Level	Security level
View	Views are divided into view reading, writing and notification.

2. Click the “Add” to fill in corresponding configuration. “Apply” and finish.

**Add Group**

---

<b>Group</b>	<input type="text"/>
<b>Version</b>	<input checked="" type="radio"/> SNMPv1 <input type="radio"/> SNMPv2 <input type="radio"/> SNMPv3
<b>Security Level</b>	<input checked="" type="radio"/> No Security <input type="radio"/> Authentication <input type="radio"/> Authentication and Privacy
<b>View</b>	<input checked="" type="checkbox"/> Read <input type="checkbox"/> Write <input type="checkbox"/> Notify

---

### 17.4.3 Community

1. Click the “Management > SNMP > Community” in the navigation bar as follows.



Interface data are as follows.

Configuration Items	Description
Community	Community configuration
Group	Group name
View	View name
Access:	Authority: read only or read-write

2. “Add” the corresponding configuration. “Apply” and finish.



### 17.4.4 User

1. Click the “Management > SNMP > User” in the navigation bar as follows.

**User Table**

Showing  entries      Showing 0 to 0 of 0 entries     

<input type="checkbox"/>	User	Group	Security Level	Authentication Method	Privacy Method
0 results found.					

Configure **SNMP Group** to associate an SNMPv3 group with an SNMPv3 user.

Interface data are as follows.

Configuration Items	Description
User	Username
Group	Group name
Security Level	Security level
Authentication Method	Authentication mode
Privacy Method	Encryption mode

2. "Add" the corresponding configuration. "Apply" and finish.

**Add User**

---

**User**

**Group**

**Security Level**

No Security  
 Authentication  
 Authentication and Privacy

**Authentication**

**Method**

None  
 MD5  
 SHA

Password

**Privacy**

**Method**

None  
 DES

Password

---

## 17.4.5 Engine ID

1. Click the “Management > SNMP > Engine ID” in the navigation bar as follows.

**Local Engine ID**

User Defined

**Engine ID**  (10 - 64 Hexadecimal Characters)

**Remote Engine ID Table**

Showing  entries      Showing 0 to 0 of 0 entries     

<input type="checkbox"/>	Server Address	Engine ID
0 results found.		

2. Click the “User Automation” to fill in corresponding ID value. “Apply” and finish.

## 17.4.6 Trap Event

1. Click the “Management > SNMP > Trap Event” in the navigation bar as follows.

<b>Authentication Failure</b>	<input checked="" type="checkbox"/> Enable
<b>Link Up / Down</b>	<input checked="" type="checkbox"/> Enable
<b>Cold Start</b>	<input checked="" type="checkbox"/> Enable
<b>Warm Start</b>	<input checked="" type="checkbox"/> Enable

Interface data are as follows.

Configuration Items	Description
Authentication Failure	Authentication error
Link Up / Down	Port link up/down
Cold start	Cold start

Warm start	Warm start
------------	------------

2. “Apply” and finish.

### 17.4.7 Notification

1. Click the “Management > SNMP > Notification” in the navigation bar as follows.

**Notification Table**

Showing  entries      Showing 0 to 0 of 0 entries     

<input type="checkbox"/>	Server Address	Server Port	Timeout	Retry	Version	Type	Community / User	Security Level
0 results found.								

For SNMPv1,2 Notification, **SNMP Community** needs to be defined.  
For SNMPv3 Notification, **SNMP User** must be created.

#### Add Notification

<b>Address Type</b>	<input checked="" type="radio"/> Hostname <input type="radio"/> IPv4 <input type="radio"/> IPv6
<b>Server Address</b>	<input type="text"/>
<b>Version</b>	<input checked="" type="radio"/> SNMPv1 <input type="radio"/> SNMPv2 <input type="radio"/> SNMPv3
<b>Type</b>	<input checked="" type="radio"/> Trap <input type="radio"/> Inform
<b>Community / User</b>	<input type="text" value="private"/>
<b>Security Level</b>	<input checked="" type="radio"/> No Security <input type="radio"/> Authentication <input type="radio"/> Authentication and Privacy
<b>Server Port</b>	<input checked="" type="checkbox"/> Use Default <input type="text" value="162"/> (1 - 65535, default 162)
<b>Timeout</b>	<input checked="" type="checkbox"/> Use Default <input type="text" value="15"/> Sec (1 - 300, default 15)
<b>Retry</b>	<input checked="" type="checkbox"/> Use Default <input type="text" value="3"/> (1 - 255, default 3)

Interface data are as follows.

Configuration Items	Description
Address Type	Address type: “Host Name”, “IPv4” or “IPv6”

Server Address	Server address info
Version	SNMP versions: v1, v2 and v3
Type	Notification type: "Trap" or "Inform"
Community / User	Community or username
Security Level	Security level
Server port	162 by default ranging from 1 to 65,535
Timeout	Timeout period: 15s by default ranging from 1 to 300s.
Retry	The retry interval ranges from 1 to 255s with 3s by default.

2. "Add" the corresponding configuration. "Apply" and finish.

## 17.5 RMON

RMON (Remote Monitoring) is a MIB defined by the IETF (Internet Engineering Task Force) and significantly emphasizes the MIB II standard. It mainly monitors data flow in a network segment or even the whole network, which is one of the widely used network management standards. RMON includes NMS (Network Management Station) and Agent running on various Network devices. RMON Agent running on network monitors or detectors will track and count flow info (e.g. the total number of messages on a network segment during a certain period of time, or that of correct messages sent to a host) on the network segment connected to the port. Based on SNMP architecture, RMON is compatible with the existing SNMP framework. SNMP monitors remote network devices in a more efficient and active manner to supervise subnet operation. RMON can reduce communication flow between NMS and SNMP Agent to manage the large-scale interconnection network conveniently and effectively. Multiple monitors can collect data by 2 means: The exclusive RMON probe is used to collect data, and the NMS directly manages info and controls network resources. All RMON MIB info can be obtained. RMON Agent with direct access to network devices (router, switch, HUB, etc.) will become the network facility with RMON probe function. RMON NMS exchanges data with SNMP Agent with SNMP basic command to collect network management info. However, limited by device resources, it generally fails to obtain all data of RMON MIB. Most devices collect data from only four groups: alarm, event, history and statistics groups. Area-type switch realizes RMON in the second way. RMON Agent directly accessing switches will become the network facility with RMON probe function. By running the SNMP Agent supported by switches, NMS can obtain overall flow, error statistics, performance statistics and other info on the network segments connected to ports, in order to manage the network.

## 17.5.1 Statistics

The statistics group info reflects the statistics of each monitoring interface on the switch, namely the info accumulated from the beginning of group creation. Statistics include the number of network conflicts, CRC error messages, too-small (too-large) data messages, broadcast/multicast messages, bytes and messages received, etc. With the RMON statistics and management functions, port usage and errors occurred can be monitored and counted respectively.

Instructions

1. Click the “Management > RMON > Statistics” in the navigation bar as follows, which reveals the port-related message statistics.

Statistics Table

Refresh Rate: 0 sec

Index	Port	Bytes Received	Drop Events	Packets Received	Broadcast Packets	Multicast Packets	CRC & Align Errors	Undersize Packets	Oversize Packets	Fragments	Jabbers	Collisions	Frames of 64 Bytes	Frames of 65 to 127 Bytes	Frames of 128 to 255 Bytes	Frames of 256 to 511 Bytes	Frames of 512 to 1023 Bytes	Frames Greater than 1024 Bytes
1	GE1	0	0	0	0	0	0	0	0	0	0	0	0	0	0	0	0	0
2	GE2	0	0	0	0	0	0	0	0	0	0	0	0	0	0	0	0	0
3	GE3	0	0	0	0	0	0	0	0	0	0	0	0	0	0	0	0	0
4	GE4	0	0	0	0	0	0	0	0	0	0	0	0	0	0	0	0	0
5	GE5	0	0	0	0	0	0	0	0	0	0	0	0	0	0	0	0	0
6	GE6	0	0	0	0	0	0	0	0	0	0	0	0	0	0	0	0	0

2. “Clear” and “Refresh” the statistics of the selected port. “View” such statistics as follows.

View Port Statistics

Port: GE8

Refresh Rate:
  None
  5 sec
  10 sec
  30 sec

Received Bytes (Octets): 0

Drop Events: 0

Received Packets: 0

Broadcast Packets Received: 0

Multicast Packets Received: 0

CRC & Align Errors: 0

Undersize Packets: 0

Oversize Packets: 0

Fragments: 0

Jabbers: 0

Collisions: 0

Frames of 64 Bytes: 0

Frames of 65 to 127 Bytes: 0

Frames of 128 to 255 Bytes: 0

Frames of 256 to 511 Bytes: 0

Frames Greater than 1024 Bytes: 0

3. Select the specified refresh frequency to operate automatically.

## 17.5.2 History

Once configuring the RMON history group, the switches will periodically collect and temporarily store the network statistics for processing ease, providing historical data on network segment flow, error packets, broadcast packets, bandwidth utilization, and other statistics. Historical data management can be used to set up devices in terms of historical data collection including periodical collection and maintenance of the data of specified ports.

Instructions

1. Click the “Management > RMON > History” in the navigation bar as follows.

**History Table**

Showing  entries Showing 0 to 0 of 0 entries

<input type="checkbox"/>	Entry	Port	Interval	Owner	Sample	
					Maximum	Current
The SNMP service is currently disabled. For RMON configuration to be effective, the <a href="#">SNMP service</a> must be enabled.						
<input type="button" value="Add"/>		<input type="button" value="Edit"/>		<input type="button" value="Delete"/>		<input type="button" value="View"/>

Interface data are as follows.

Configuration Items	Description
Entry	Serial No. of event groups
Port	Ports to be counted
Interval	Sampling interval ranging from 1 to 3,600 (unit: s), with 1,800s by default.
Owner	Owner
Maximum	The max number of samples ranges from 0 to 50, with 50 by default.
Current	Current number of samples

2. “Add” corresponding configuration items to configure history group.

**Add History**

**Entry** 1

**Port** GE1

**Max Sample** 50 (1 - 50, default 50)

**Interval** 1800 (1 - 3600, default 1800)

**Owner**

Apply Close

3. "Apply" and finish as follows.

**History Table**

Showing All entries Showing 1 to 1 of 1 er

	Entry	Port	Interval	Owner	Sample	
					Maximum	Current
<input type="checkbox"/>	1	GE1	1800		50	50

The SNMP service is currently disabled.  
For RMON configuration to be effective, the [SNMP service](#) must be enabled.

Add Edit Delete View

### 17.5.3 Event

Defining event No. and process way, event group is mainly for the events triggered by alarm group configuration items and extended alarm group configuration items. There are several solutions to them: recording in a log table; transmitting a Trap messages to NMS; recording a log and transmitting a Trap message; Don't care.

Instructions

1. Click the "Management > RMON > Event" in the navigation bar as follows.

**Event Table**

Showing All entries Showing 0 to 0 of 0 entries

	Entry	Community	Description	Notification	Time	Owner
0 results found.						

First Previous 1 Next Last

The SNMP service is currently disabled.  
For RMON configuration to be effective, the [SNMP service](#) must be enabled.

Add Edit Delete View

Interface data are as follows.

Configuration Items	Description
Entry	Serial No. of event groups
Community	Community name
Description	Description
Notification	Notification
Timer	Time
Owner	Owner

2. “Add” corresponding configuration items to configure the event group.

**Add Event**

---

<b>Entry</b>	1
<b>Notification</b>	<input checked="" type="radio"/> None <input type="radio"/> Event Log <input type="radio"/> Trap <input type="radio"/> Event Log and Trap
<b>Community</b>	Default Community
<b>Description</b>	Default Description
<b>Owner</b>	

Apply Close

---

3. “Add” and finish as follows.

**Event Table**

Showing All entries Showing 1 to 1 of 1 entries

<input type="checkbox"/>	Entry	Community	Description	Notification	Time	Owner
<input type="checkbox"/>	1	Default Description	Default Description	Event Log and Trap		

First Previous 1 Next Last

The SNMP service is currently disabled.  
For RMON configuration to be effective, the [SNMP service](#) must be enabled.

Add Edit Delete View

---

## 17.5.4 Alarm

RMON alarm management monitors specific alarm variables, such as port statistics.

An alarm event occurs when the value of monitored data exceeds the defined threshold in the corresponding direction, which will be treated according to the prescribed treatment mode. Event definition is realized in event group. After the user defines the alarm entry, the system will process as follows: The alarm-variable defined by sampling-time should be sampled and the value should be compared with the threshold. For higher threshold, the corresponding event will be triggered.

1. Click the “Management > RMON > Alarm” in the navigation bar as follows.



Interface data are as follows.

Configuration Items	Description
Entry	Serial No. of alarm groups
Port	Enter the ports to be counted
Counter	Sample parameters of alarms
Interval	Sampling interval ranges from 1 to 2,147,483,647 with the unit of second. 100s by default.
Sampling	Sample types: Absolute and Delete
Owner	Owner
Threshold (Rising)	The threshold of rising edge ranges from 0 to 2,147,483,647.
Event (Rising)	Event group index. Corresponding event will be activated when alarm is triggered.
Threshold (Falling)	The threshold of falling edge ranges from 0 to 21,474,836,475.
Event (Falling)	Event group index. Corresponding event will be activated when alarm is triggered.

2. “Add” corresponding configuration items to configure the alarm group.

## Add Alarm

<b>Entry</b>	1
<b>Port</b>	GE1
<b>Counter</b>	Drop Events
<b>Sampling</b>	<input checked="" type="radio"/> Absolute <input type="radio"/> Delta
<b>Interval</b>	100 Sec (1 - 2147483647, default 100)
<b>Owner</b>	
<b>Trigger</b>	<input checked="" type="radio"/> Rising <input type="radio"/> Falling <input type="radio"/> Rising and Falling
<b>Rising</b>	
<b>Threshold</b>	100 (0 - 2147483647, default 100)
<b>Event</b>	1 - Default Description
<b>Falling</b>	
<b>Threshold</b>	20 (0 - 2147483647, default 20)
<b>Event</b>	1 - Default Description

3. "Apply" and finish as follows.

## Alarm Table

Showing All entries      Showing 1 to 1 of 1 entries     

	Entry	Port	Counter		Sampling	Interval	Owner	Trigger	Rising		Falling	
			Name	Value					Threshold	Event	Threshold	Event
<input type="checkbox"/>	1	GE1	DropEvents	0	Absolute	100		Rising	100	Default Description	20	Default Description

The SNMP service is currently disabled.  
 For RMON configuration to be effective, the SNMP service must be enabled.